



O P E R A T I N G
M A N U A L

slee solutions
for
pathology

STAINING SYSTEMS
Cromatec I / II

FLEXIBLE STAINING SYSTEMS
WITH HIGHEST THROUGHPUT

DESIGN &
MANUFACTURING
MADE IN GERMANY

Table of Content

1 Introduction

1.1 About this manual	5
1.1.1 Used symbols and their meanings	5
1.2 Intended use	6
1.3 Authorized operators	6
1.4 Instrument type	6
1.5 Safety Instructions for working with the Cromatec I / II and reagents	7

2 Components of the Cromatec linear stainer

2.1 Instrument components	9
2.2 Standard components	10
2.3 Technical specification	10

3 Setting up the instrument

3.1 Installation site requirements	13
3.2 Tap water supply connection	14
3.3 Waste water hose connection	15
3.4 Electrical connection	17
3.5 Connection of air evacuation (optional)	17
3.6 Inserting/Changing the activated carbon filter	17
3.7 Levelling the instrument	18
3.8 Inserting the cuvettes	19
3.9 Inserting the slide baskets	20
3.10 Setting the water pressure for running water station	21
3.11 Store samples in xylene at the end of the process	21

4 Operation

4.1 Switching on the instrument	22
4.2 Main menu	22
4.3 Programs – only for Administrator	
4.3.1 Edit a new or existing program	30
4.4 Users – only for Administrator	
4.4.1 Edit a new or existing user	38
4.5 Reagents – only for Administrator	
4.5.1 Edit or create a new reagent	43

4.6 Settings	
4.6.1 Setting of Cromatec	48
4.6.2 Agitation / Fan	49
4.6.3 Filter	50
4.6.4 Options	53
4.6.5 Language	54
4.6.6 Time and date	55
4.6.7 Display	56
4.6.8 Service	58
4.7 Running staining program	
4.7.1 Place slide baskets in the loading station	59
4.7.2 Select the program you want to stain	59
4.7.3 Start the program	61
4.7.4 Symbols during program	63
4.7.5 End of program	64
4.7.6 Stop a running program	65
4.7.7 Emergency stop	66
5 Errors	
5.1 Notes	67
5.2 PopUp messages	67
5.3 Error messages	70
5.4 Power failure	72
5.5 Hood	73
6 Cleaning	
6.1 General cleaning advice	74
6.2 Disposal	74
6.3 Schedule of cleaning for staining system	75

1. Introduction

1.1 About this Manual

This manual shall help you handling the device. Please read the manual completely and follow the advice. Acquaint yourself to the control elements and their functionality by studying the figures. This way, an adequate use of the device is ensured.

1.1.1 Used symbols and their meanings



Danger warning: Danger warnings are marked by a red framed triangle.



Warning: Warnings are marked with a yellow warning triangle, showing an exclamation mark.



Flammability: Warnings regarding flammability are marked with a yellow triangle, showing a flame.



Heat warning: Heat warnings identify parts and situations of the device with high temperatures.



Notice: Notices, meaning important information for the user, that are not classified as danger or warning, are marked with an information symbol.

1.2 Intended Use

The Cromatec I / II is an automated stainer and is made for the purpose of staining tissue specimens in histology and pathology laboratories only. The instrument may be operated only according to the instructions contained in this manual. Any other use of the Cromatec I / II is considered improper.

The conditions for operation, maintenance and service mentioned in this instruction manual have to be strictly observed.



To prevent damages to the instrument and specimens, only use accessories and spare parts which have been approved by SLEE medical GmbH.

1.3 Authorized Operators

The Cromatec must be used only by those persons who have been authorized by the owner. In his working area, the operator is responsible with regard to third persons. The owner must give the operator access to this instruction manual and make sure that the operator has read and understood its contents.

1.4 Instrument type

All information provided in this manual applies only to the instrument type indicated on the title page. A name plate indicating the instrument serial number is attached to the rear panel of the instrument.

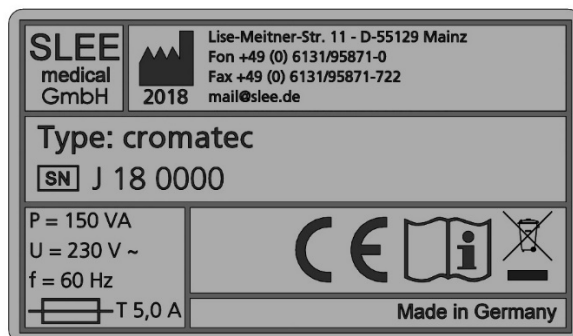

1.5 Safety Instructions for working with the Cromatec I / II and reagents

When working with the Cromatec I / II, please pay particular attention to the used reagent's characteristics regarding flammability and further hazards. Read the manual carefully before working with the Cromatec I / II and reagents for the first time. Keep the manual near and easily accessible to the device. Consult the manual in case of obscurities.



Many reagents' fluids and vapours are flammable. If you are not sure about using a reagent, please contact the manufacturer.



Always wear protective clothes (e.g. laboratory coat, gloves, safety glasses) to prevent accidental contact with reagents!



Do not eat, drink or otherwise consume reagents and/or reagent vapours! Do not eat, drink, smoke within the surrounding area of the device!



In case of accidental eating or drinking of, or skin contact with a reagent or its vapours, immediately consult the correspondent safety data sheet and follow the instructions stated in the corresponding sections!



Make sure the exhaust air decontamination system is working before starting to work with the Cromatec and reagents!



Ensure that the device is cleaned and maintained according to the schedule and advice given in Chapter 5!



If the cromatec II is not in use, the water supply must be switched off at the tap independently. In case the device becomes a defect, the warranty expires.



If you have trouble understanding instruction, questions, or are not sure about the safety, please consult your Sales Representative first!

- **An incorrect operation may stop or interrupt tissue processing. Make sure that the device is not interfered with or changed by unauthorized personnel during operation.**

An incorrect operation may stop or interrupt tissue processing. (If power is turned off by unauthorized personnel, the dying process may be interrupted and dyeing problems may occur.) Design the work environment so that only operators with expertise can use the machine. (As a precaution, also consider the use of external alarms, etc.)

- **Do not bring open flames near the device.**

The device uses organic solvents that can ignite when exposed to fire.

- **Never allow foreign objects to enter the device.**

The ingress of water, metal, paper or other foreign objects into the air inlets (to the fan, etc.) may result in fire, electric shock, operator injury, equipment failure, etc. If foreign objects have entered the device, switch off the device immediately and contact the technical service department or a local representative of SLEE medical GmbH.

- **Do not operate the device while wearing metal objects on the body.**

Body-worn wires (pins, jewelry, clothing, etc. made of metal) may come into contact with the device and cause an electric shock.

- **Never block the ventilation openings or air inlets on the device.**

Never block the ventilation openings (air inlets) by setting them up against a wall or objects, and do not use the unit in a poorly ventilated place or with the dust cover still attached. This can lead to heat build-up in the device and a drop in its performance and also cause fires, accidents, failures, etc. due to abnormal overheating.

- **Check the power cord, other cables and the power outlet regularly for damage and dust accumulation.**

Foreign objects and dust accumulation on the wall outlet can cause fires. Clean the mains socket at regular intervals.

- **Make sure that no tissue gets into the drying station and still sticks with flammable solvent.**

If stored flammable solvents are heated in the drying station and evaporate, this can cause fires or explosions.

- **Do not place the device in a place that is used as a living area.**

If a common room is used, an exhaust system is required. Provide protection against electrostatic discharge at the installation site.

- **Install the device indoors. Do not place the unit in a location exposed to direct sunlight, snow or rain.**

This product is designed for indoor use; do not use it outdoors. UV radiation and high temperatures can cause damage to the device. Never use the device when it is exposed to snow or rain, as this could result in electric shock or short circuit.

2. Components of the Cromatec I / II linear stainer

2.1 Instrument Components

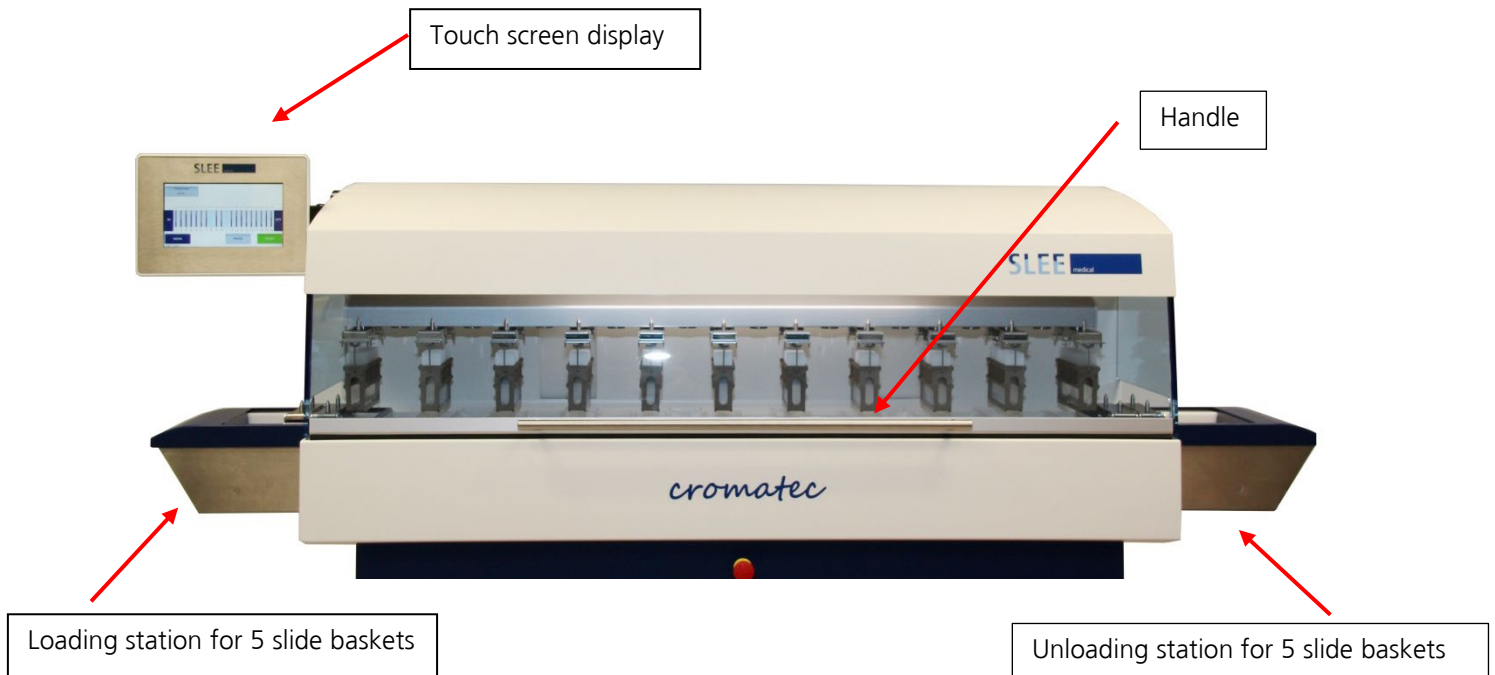

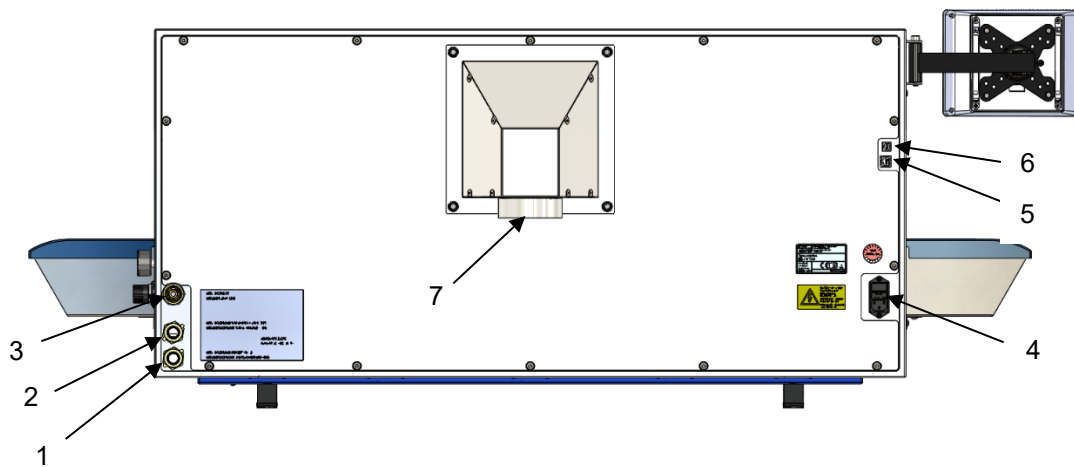
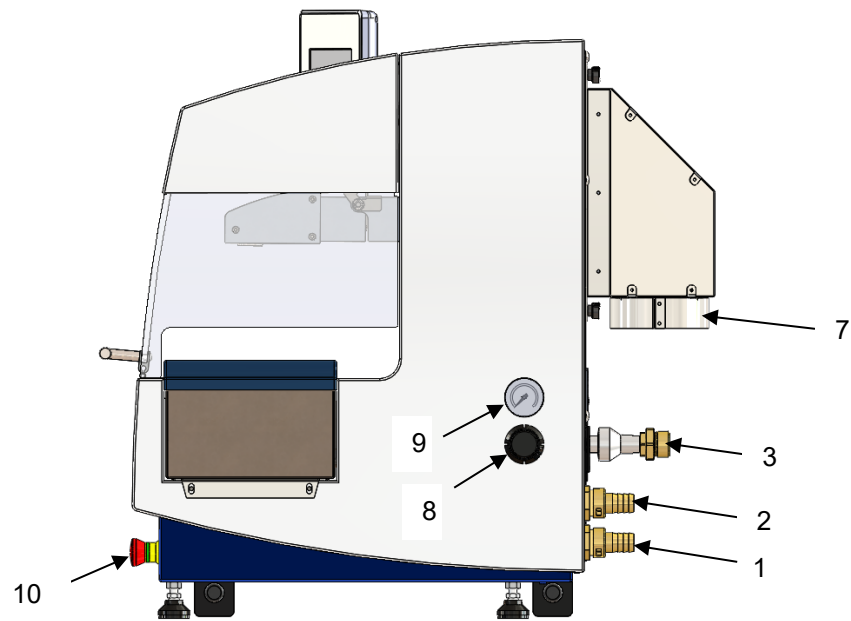

1	Water drain receptacle
2	Water drain washing cuvettes
3	Water connection / inlet
4	Connection power cable
5	Network connection RJ45
6	USB connector type B
7	Hose connection exhaust air Ø 100 mm
8	Water flow pressure regulator
9	Pressure gauge
10	Emergency stop button

2.2 Standard components

Cromatec I

Art.-No.:	Description	Quantity
41000566	Cover plate	2 pcs
41000017	Plastic cuvettes normal	20 pcs
41000410	Plastic washing cuvettes complete	6 pcs
41000584	Insert tub assembled	1 pcs
41000580	Drip tray with lifting plate	1 pcs
41000270	Receiving bracket	6 pcs
38500051	Slides	6 pcs
41000655	Inlet hose	1 pcs
41000657	Drain hose à 2 m	2 pcs
33010428	Hose clamp (mounted)	2 pcs
41000654	Reducer $\frac{3}{4}$ x $\frac{1}{2}$ inch	1 pcs
-	Mains cable	1 pcs
-	Instruction manual	1 pcs
41000558	Transport handles	4 pcs

Cromatec II

Art.-No.:	Description	Quantity
41000750	Heating cuvette / drying station Adjustable from 30 °C until 70 °C	1 pcs
41000767	Filter pad for heating cuvette, for collecting dripping wax	1 pcs
41000566	Cover plate	2 pcs
41000017	Plastic cuvettes normal	20 pcs
41000410	Plastic washing cuvettes complete	6 pcs
41000584	Insert tub assembled	1 pcs
41000580	Drip tray with lifting plate	1 pcs
41000270	Receiving bracket	6 pcs
38500051	Slides	6 pcs
41000655	Inlet hose	1 pcs
41000657	Drain hose à 2 m	2 pcs
33010428	Hose clamp (mounted)	2 pcs
41000654	Reducer $\frac{3}{4}$ x $\frac{1}{2}$ inch	1 pcs
-	Mains cable	1 pcs
-	Instruction manual	1 pcs
41000558	Transport handles	4 pcs
41000782	Extension cable for drying station	1 pcs

2.3 Technical Specification

General

Nominal Voltage	100 – 240 V AC +/- 10 %
Nominal frequency	50 / 60 Hz
Max. power consumption	350 VA
Max. heat emission	350 J/s
IEC 1010 classification	Protective class 1 Pollution degree 2 Overvoltage installation category II
Fuses	2 x T 3,15 A
Interfaces	USB, RJ 45
Operating temperature range	+10 to +35 °C
Operating humidity	max. rel. 80 % non-condensing
Storage temperature range	+5 to +55 °C
Storage humidity	max. rel. 80 % non-condensing
Battery running time	4 h (the heating station is switched off in battery mode)
Exhaust air volume	Minimum air volume approx. 200 m ³ /h, required pressure difference of approx. 100 Pascal (Pa), nominal diameter for hose connection on the back is 100 mm

Dimensions and weight

Dimensions (W x D X H)	1.560 mm x 640 mm x 620 mm
Weight unpacked (without accessories)	120 kg

Capacity

Specimen slide throughput	Up to 1.800 slides/h*
Loading capacity	Up to 20 slide baskets simultaneously
Slide basket capacity	30 slides
Total number of stations	19 + 1 heating / drying station
Number of heating / drying stations	1
Temperature heating stations	30 – 70 °C
Number of washing stations	Max. 6
Reagent / Washing cuvettes volume	400 ml
Water flow regulation for washing stations	0,5 to 2,0 l/min
Load / Unload stations	5 each
Programs	20 programs, up to 20 steps each
Incubation time setting	5 sec. up to 59 min, 59 sec.

*depending on staining protocol

3. Setting up the instrument

3.1 Installation site requirements – first time

Requirements for the installation site:

- The device may only be used indoors.
- Stable, precisely horizontal laboratory table with a uniform surface of 1.80 m and a depth of 0.80 m, which can hold a weight of 120 kg!
- The minimum distance between the device and the wall or other instruments should be at least 10 cm to ensure adequate ventilation. Also make sure that there are no flammable objects in the area heated by the unit.
- Tap water connection of maximum 2.50 m and waste water pipe of 2.00 m from the corresponding input / output on the rear wall of the device.
- If the device is to be operated with an exhaust air hose, a fume cupboard with a maximum distance of 3.50 m from the device is required. Alternative: Operation with activated carbon filter.
- Sufficient space of min. 0.90 m above the bench to easily open / close the instrument cover.
- Stable ambient temperature between + 10 ° C and + 35 ° C
- Relative humidity of maximum 80%, non-condensing.
- Do not place any equipment nearby that could cause vibration.
- The device must not be exposed to direct sunlight.

Lift the instrument by carrying the handles (see picture below). Four people are needed to lift and / or carry the instrument as the instrument weighs approximately 120 kg in total.

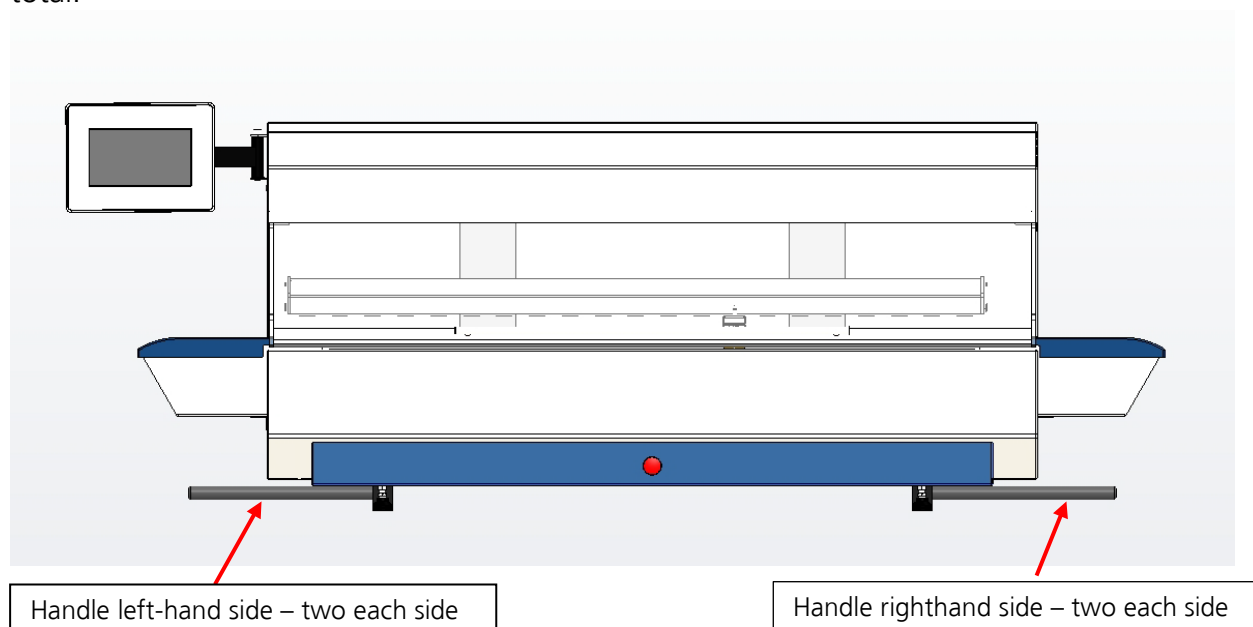

After installation please remove the handles on both sides!

3.2 Tap water supply connection

- Unpack the water inlet hose (including safety-aqua stop).
- Connect the hose to the inlet connection.



Always connect the water inlet hose!



3.3 Waste water hose connection

- Connect the waste hose to the waste water connection. Please note that water can escape in the upper drain hose, but in the lower only in an exceptional case.

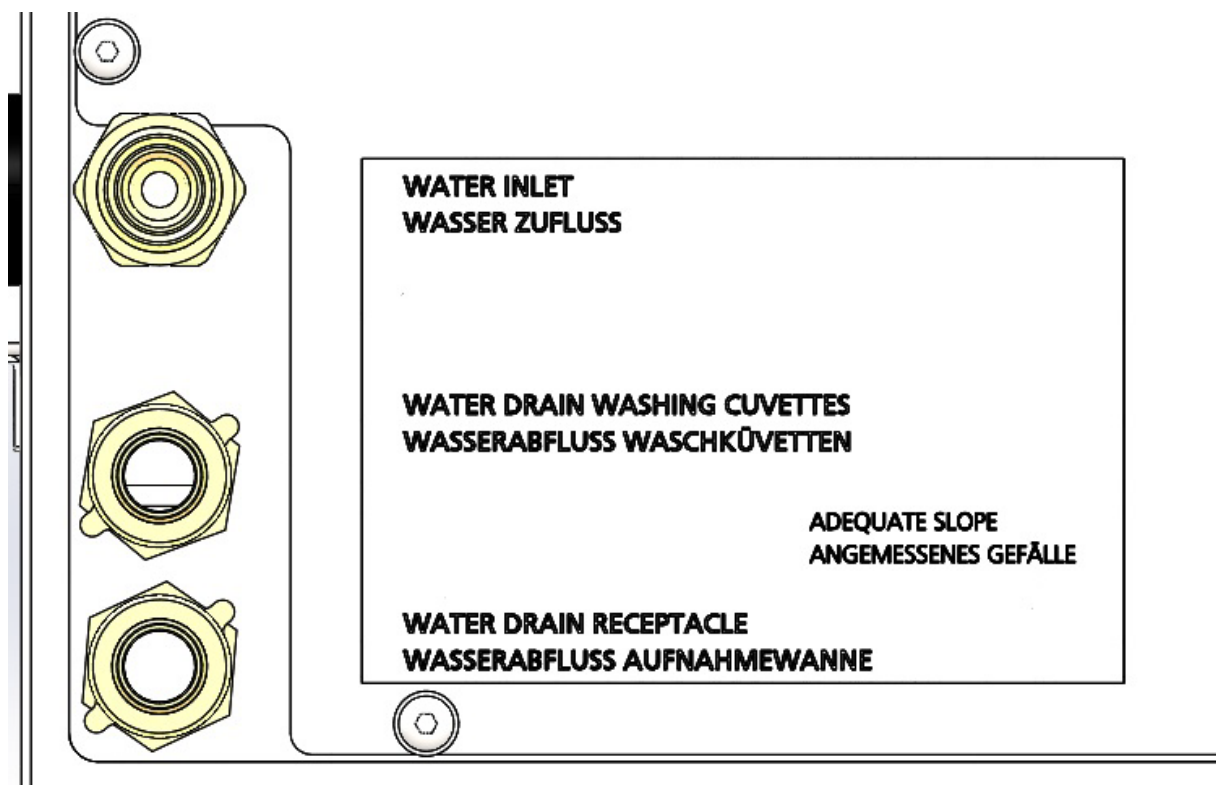
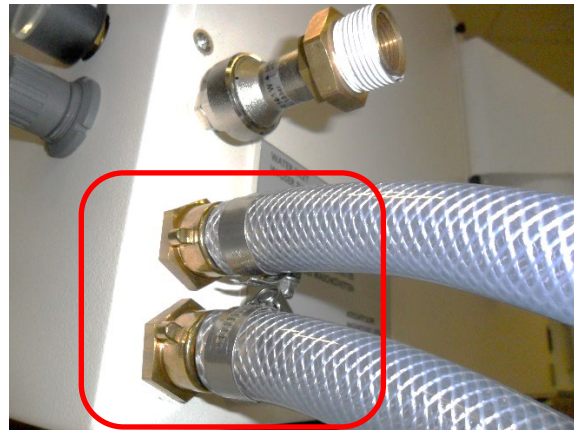

i

Please do not bend the hoses and ensure an adequate slope.

i

The two drains on the rear of the unit must never be brought together.

i

The lower drain is to be used only for cleaning purposes to rinse and clean the cuvette trough. Connect as required and provide sufficient slope.

i

The upper drain is only for the maximum of 6 water baths and must be connected constantly with sufficient slope.

3.4 Electrical connection

- The electrical connection is located at the rear of the unit.
- Connect the mains cable to the mains power supply socket.



The instrument must be connected to a grounded mains power outlet socket. Make sure to use the appropriate mains cable for the local voltage supply.



3.5 Connection of air evacuation (optional)

- For the connection to an external air evacuation please contact the local Slee service.

3.6 Inserting / Changing the activated carbon filter



The Cromatec will be delivered with the filter already installed.

- For changing the filter, unscrew the 4 screws at the rear of the instrument panel.
- Take out the filter and replace with a new one.
- Connect the filter housing to the rear panel again.
- Set filter change in the menu (see chapter 4.6.3).

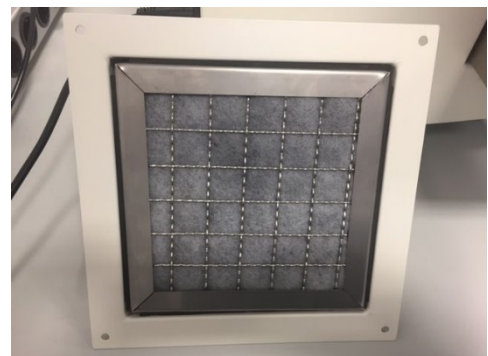
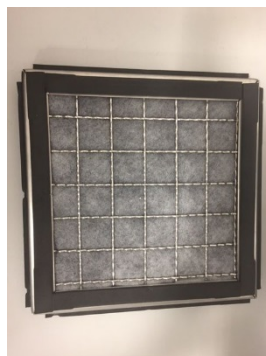

3.7 Leveling the instrument

- Once all accessories are installed move the instrument to its final position.
- The easiest way to find the right level is using a spirit level.
- The right level will be achieved by adjusting the instrument feet.



3.8 Inserting the cuvettes

- There are three different cuvette types:
 - Reagent cuvettes
 - Running water cuvettes
 - Heating cuvette / drying station (only Cromatec II)



Reagent cuvette



The reagent cuvette can simply be placed at the any station.



Washing cuvette



The washing cuvette can simply be clicked into the water tube at the button of the station. The position can be freely selected.

Only Cromatec II: Inserting the heating cuvette / drying station



Heating cuvette / drying station

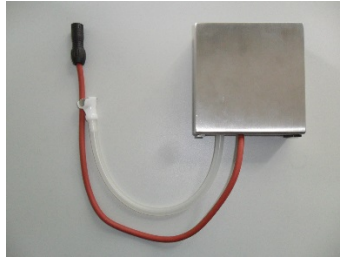

Connection of heating cuvette / drying station



The heating cuvette is only available once in the device, as a heating cuvette / drying station in station 1, or as a heating cuvette / drying station in station 20. Only the plastic cuvette in station 1 or 20 is replaced by the heating cuvette or drying station. The heating station in station 1 the power supply and air supply are connected directly at the bottom left of the tub. For dry station in station 20, the power supply and the air supply are connected each with an extension in the bottom left of the tub. When placing the power supply and the air supply, it is important to ensure proper installation. For power connection, the white mark on the plug must face up.

This following step is very important to obey: In station 1 as hot air station, the figure 1 on the housing facing to the user. In station 20 as drying station, the figure 20 must face to the user, so the hot air station has to be turned 180 degrees.



Please do not use chloroform, acetone and toluene (Methylbenzene).

3.9 Inserting the slide baskets

- The slide basket carrier system consists of two parts:
 - The slide basket for 30 slides
 - The basket carrier to connect to the magnet system

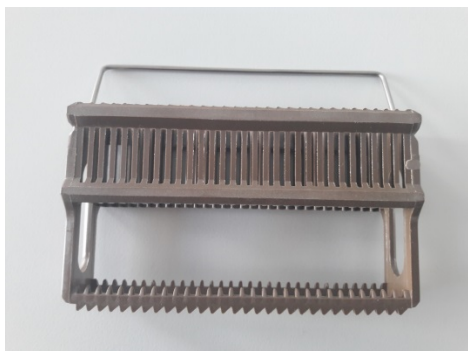

To make sure the slide basket is not falling out of the transport system, you can hold it with your finger as shown in the picture.



The transport system has to be clean at all time to make sure the magnets are taking the full slide baskets. Please do not use the instrument with just the transport system but always with a basket inserted.



Please pay attention to an even load.

3.10 Setting the water pressure for running water station

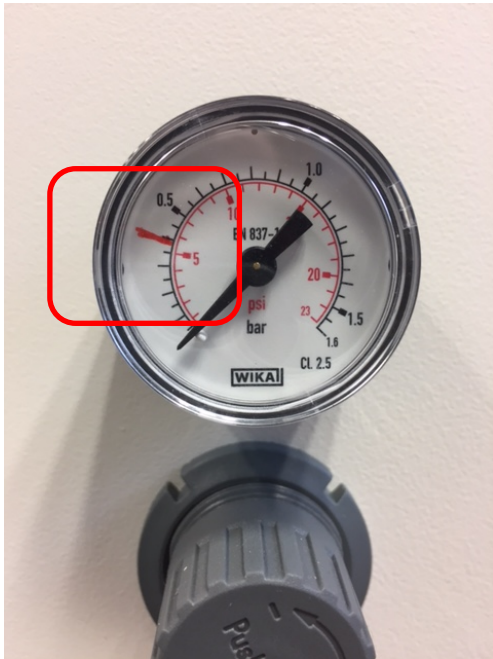

The red marking indicates the maximum flow pressure during operation.

3.11 Store samples in xylene at the end of the process

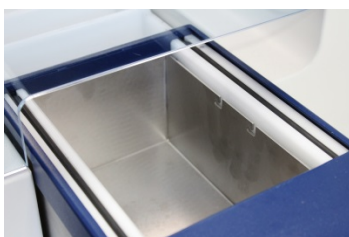
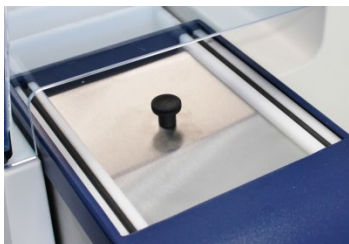
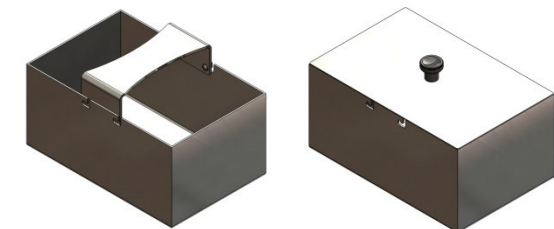

For this purpose, an insert tray with bow handle and lid was specially developed so that the samples can be stored in xylene at the end of the process. The bow handle may only be used to remove the tray from the spout pan; otherwise the lid collapses so that the xylene does not evaporate (over night or when not in use for a long time), it must not remain in the device during the process.

4. Operation

4.1 Switching on the instrument

Switch on the device at the main switch at the rear panel of the instrument.



4.2 Main menu

After switching on the instrument for the first time, the system starts booting and the following display is shown:

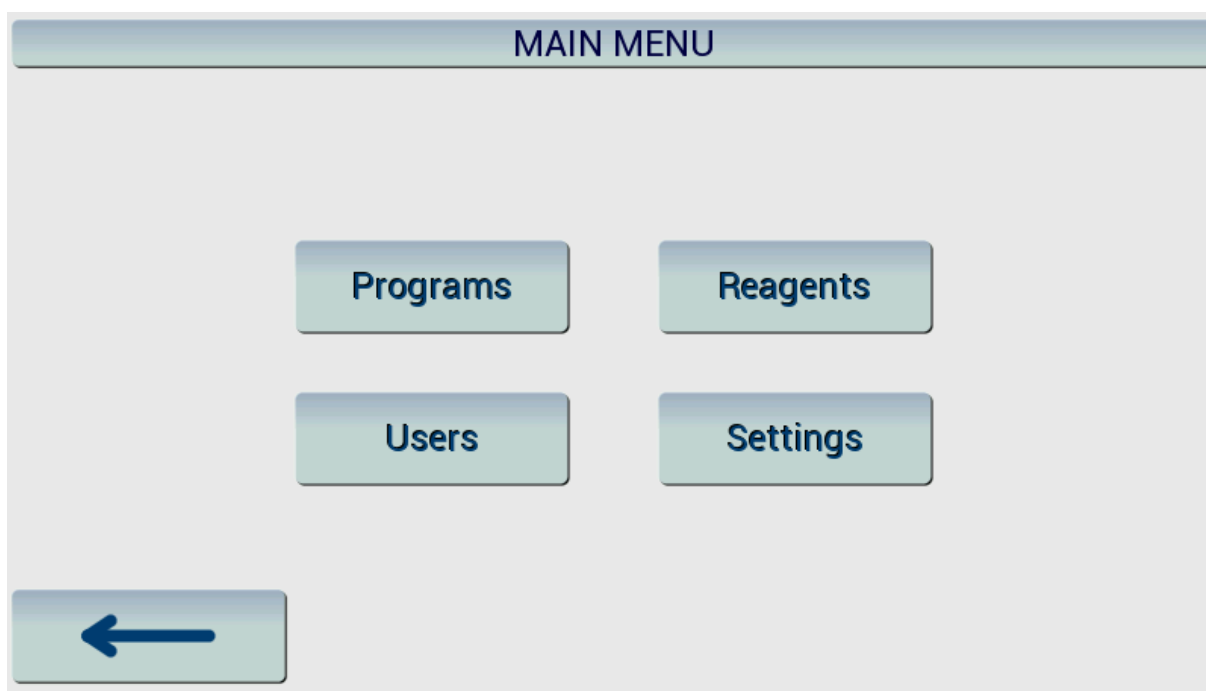

From this status all functions are started.

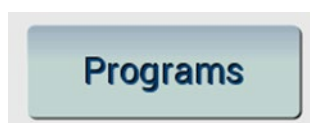

The "Programs" button is for selection and changing of programs.

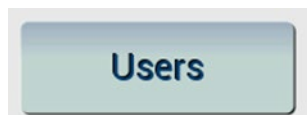

The "Users" button is to set and change user data

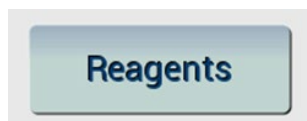

The "Reagents" button is for managing the reagents.

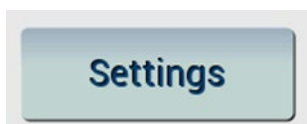

The "Settings" button is for general settings.

After switching on the instrument for the first time, the system starts booting and the following display is shown:

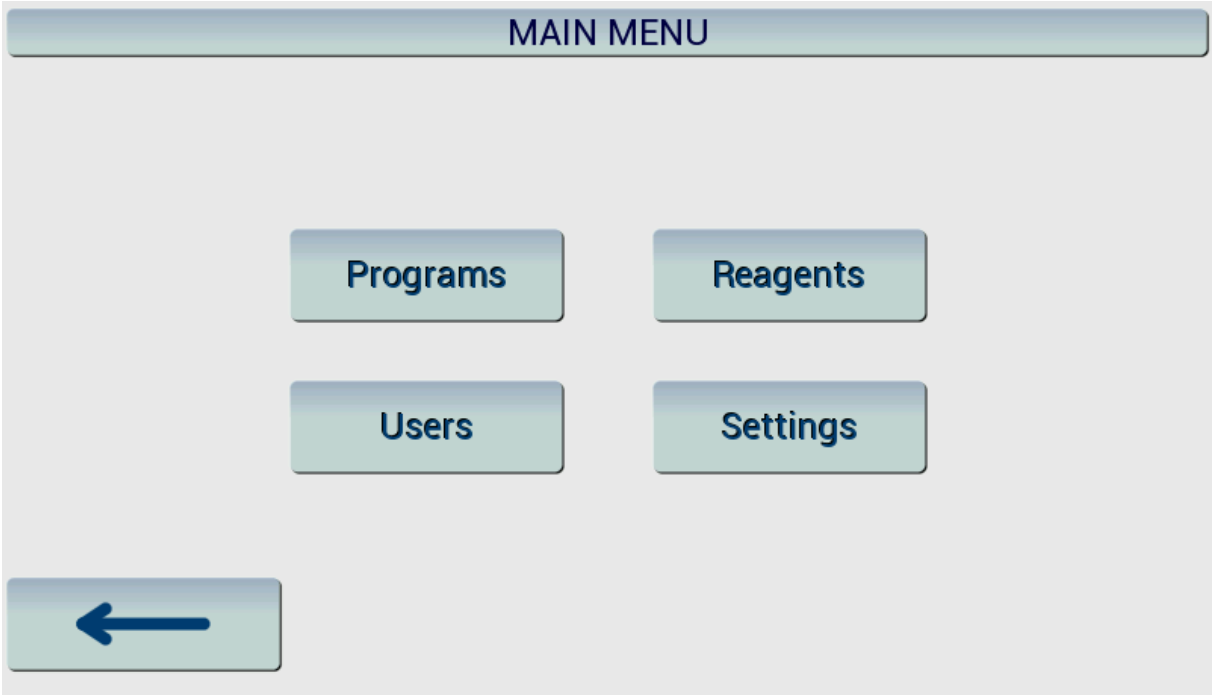

Please follow the below instructions to save a new user.

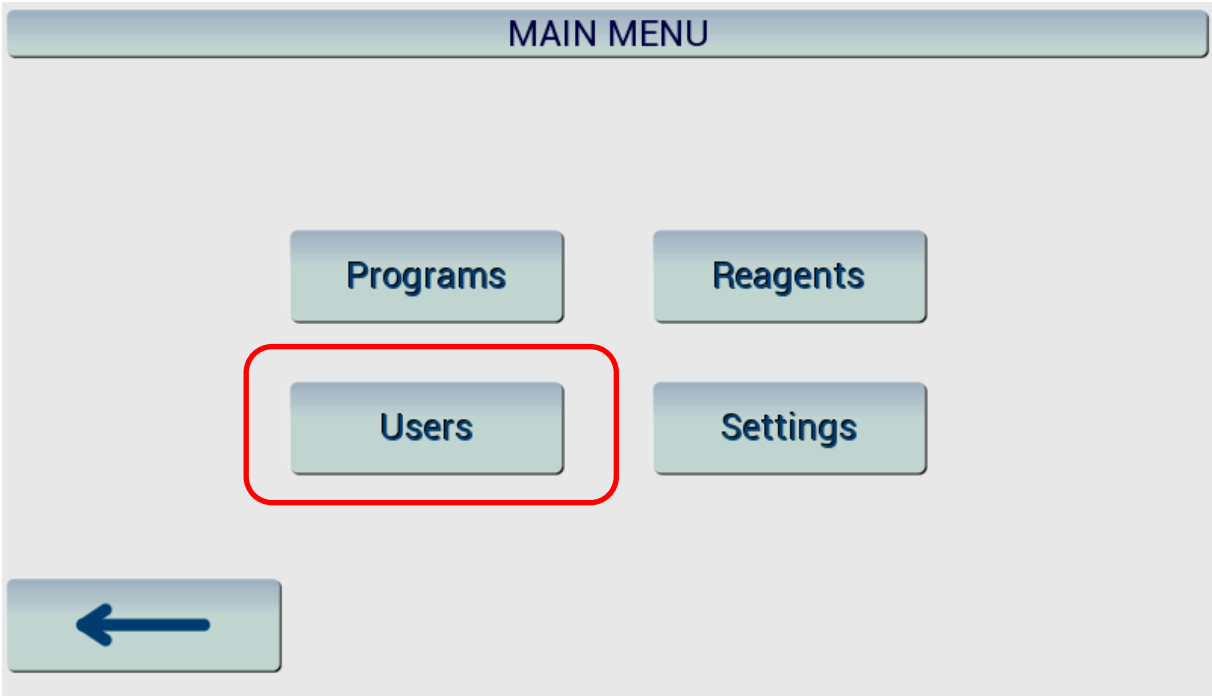

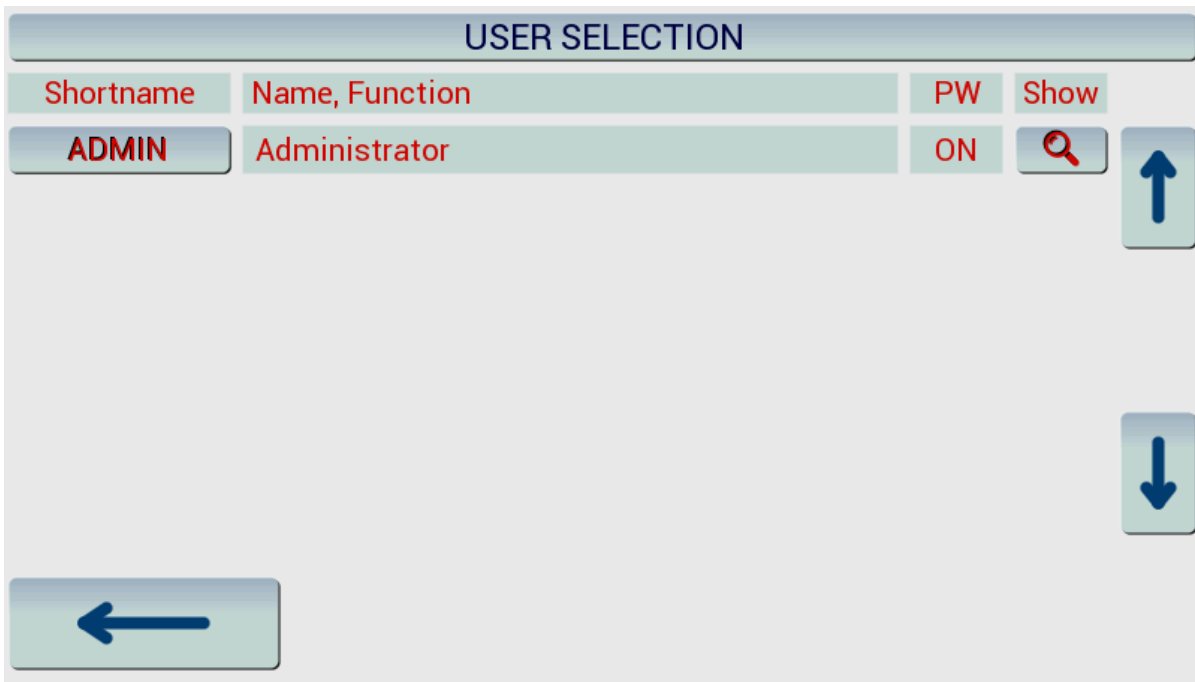

Please press "ADMIN" and enter with password the below instructions to save a new user.

With the magnifier you can change the values of the user. If you want to add a user please press "New".

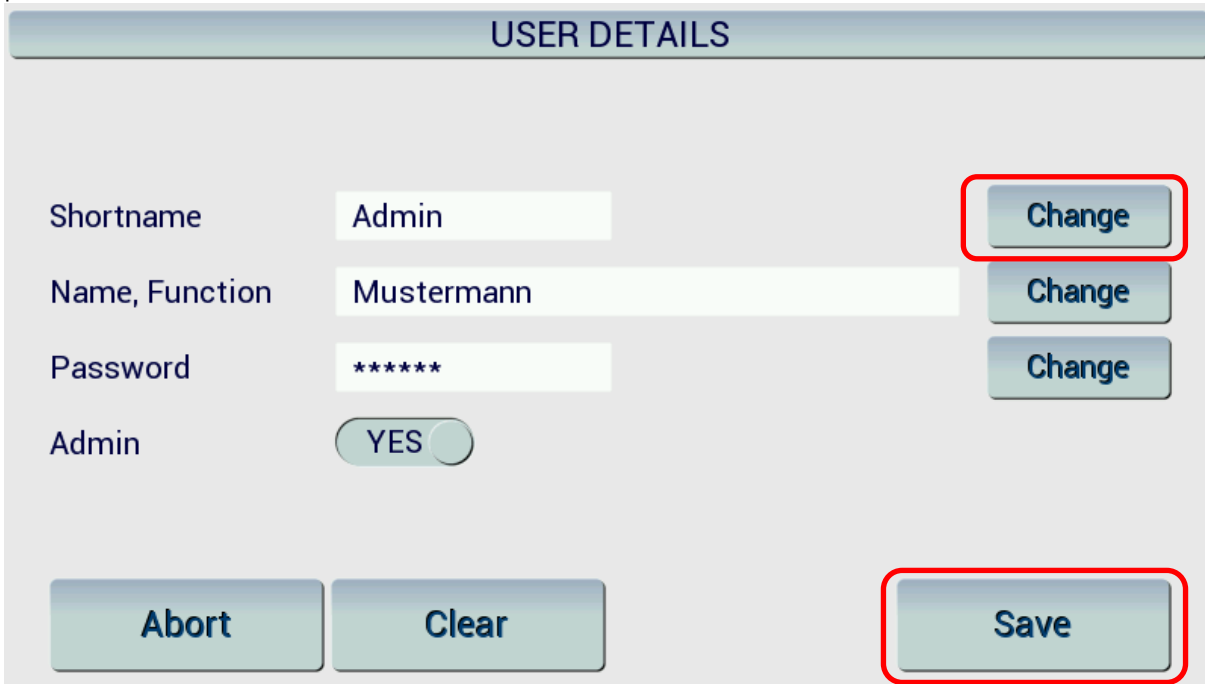

Press "Change" behind Short name to enter the Short name of the user.

Enter Shortname:

q	w	e	r	t	y	u	i	o	p	7	8	9
a	s	d	f	g	h	j	k	l	%	4	5	6
z	x	c	v	b	n	m	,	.	-	1	2	3
^										0	()

Admin|

Abort

<-

OK

Please confirm with ok and to return to menu user details.

USER DETAILS

Shortname	Admin	Change
Name, Function	Mustermann	Change
Password	*****	Change
Admin	YES	

Abort

Clear

Save

Press change behind Name, Function to enter the Name and Function or Department of the user.

Enter Name and Function:

q	w	e	r	t	y	u	i	o	p	7	8	9
a	s	d	f	g	h	j	k	l	%	4	5	6
z	x	c	v	b	n	m	,	.	-	1	2	3
^										0	()

Mustermann|

Abort

<-

OK

Please confirm with ok and to return to menu user details.

USER DETAILS

Shortname	Admin	Change
Name, Function	Mustermann	Change
Password	*****	Change
Admin	YES	

Abort

Clear

Save

Press change behind Password to change the password. If <none> is selected, there is no password active.

Enter new password:

q	w	e	r	t	y	u	i	o	p	7	8	9
a	s	d	f	g	h	j	k	l	%	4	5	6
z	x	c	v	b	n	m	,	.	-	1	2	3
^										0	()

****|

Abort

<-

OK

Please confirm with ok and to return to menu user details.

USER DETAILS

Shortname	Admin	Change
Name, Function	Mustermann	Change
Password	*****	Change
Admin	YES	

Abort

Clear

Save

Please confirm everything with save and to return to menu user selection.

USER SELECTION				
Shortname	Name, Function	PW	Show	
ADMIN	Max Mustermann, Administrator	ON		
Admin	Mustermann	ON		

With the arrow you can return to the main menu.

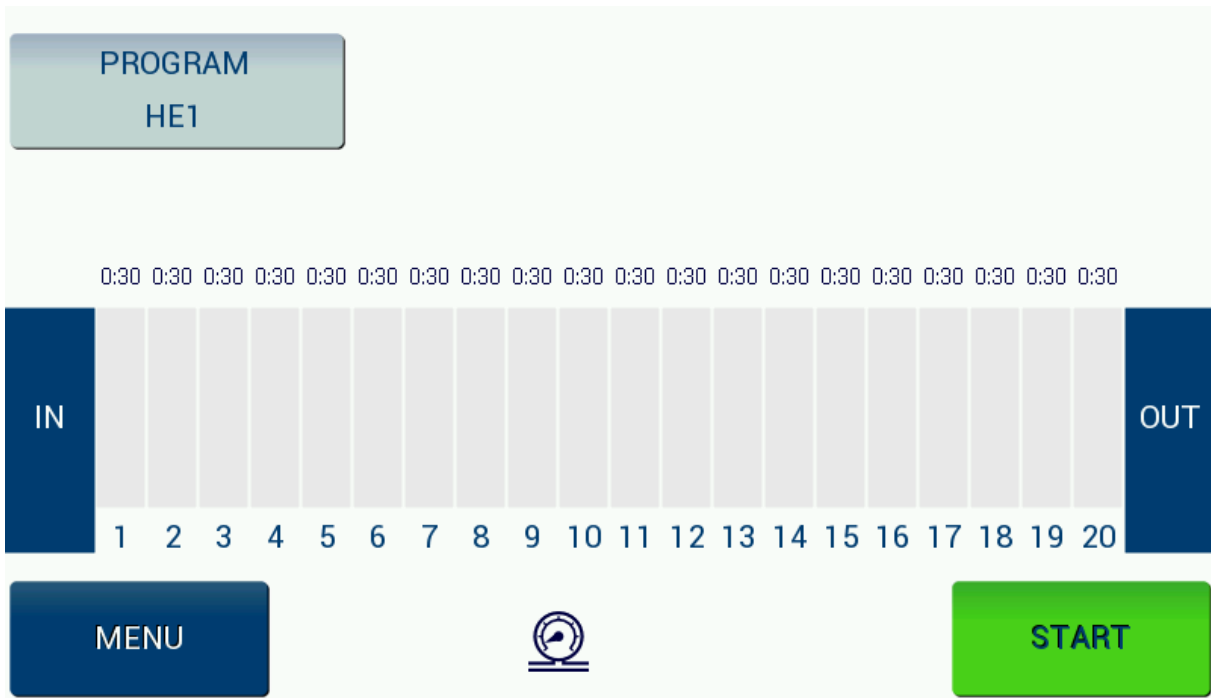

Please note that in this case, the last user is the actual user. If you want to change from user to administrator please follow the instructions in chapter 4.4.1.

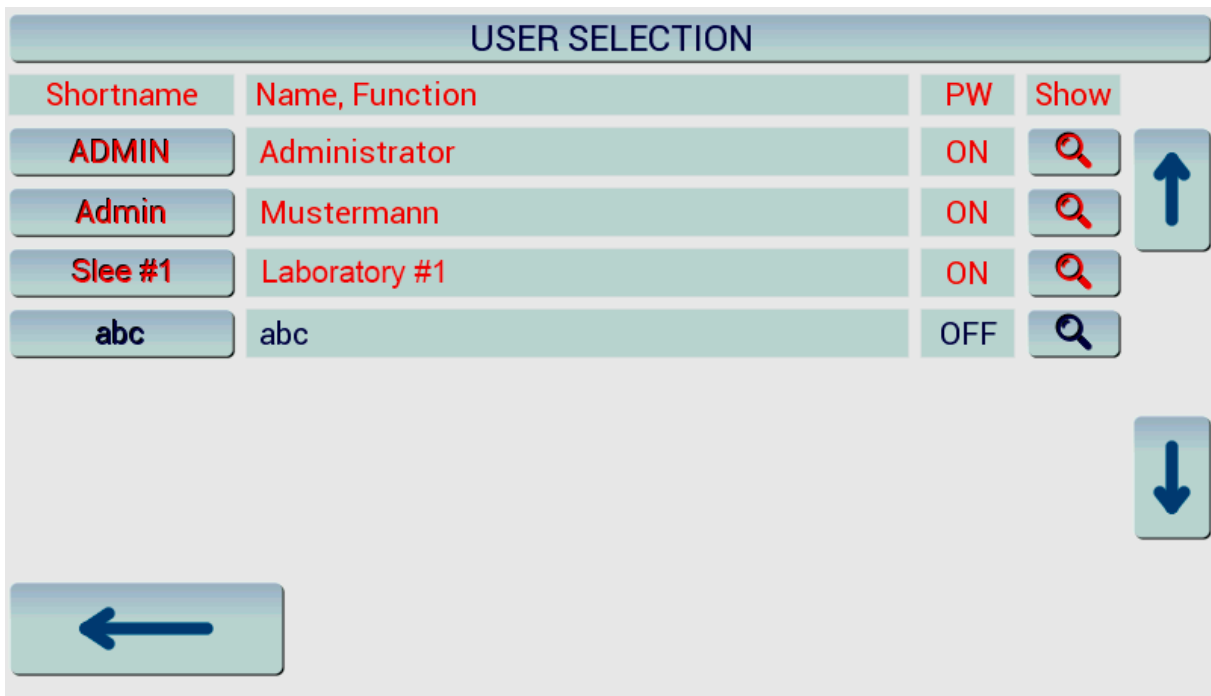

The following described changes can only be done through an Administrator.

4.3 Programs



The following instructions (4.3.1 until 4.5.1) can only be done by the Administrator!

4.3.1 Edit a new or existing program

Please follow the below instructions to save a new program or to edit an existing program.

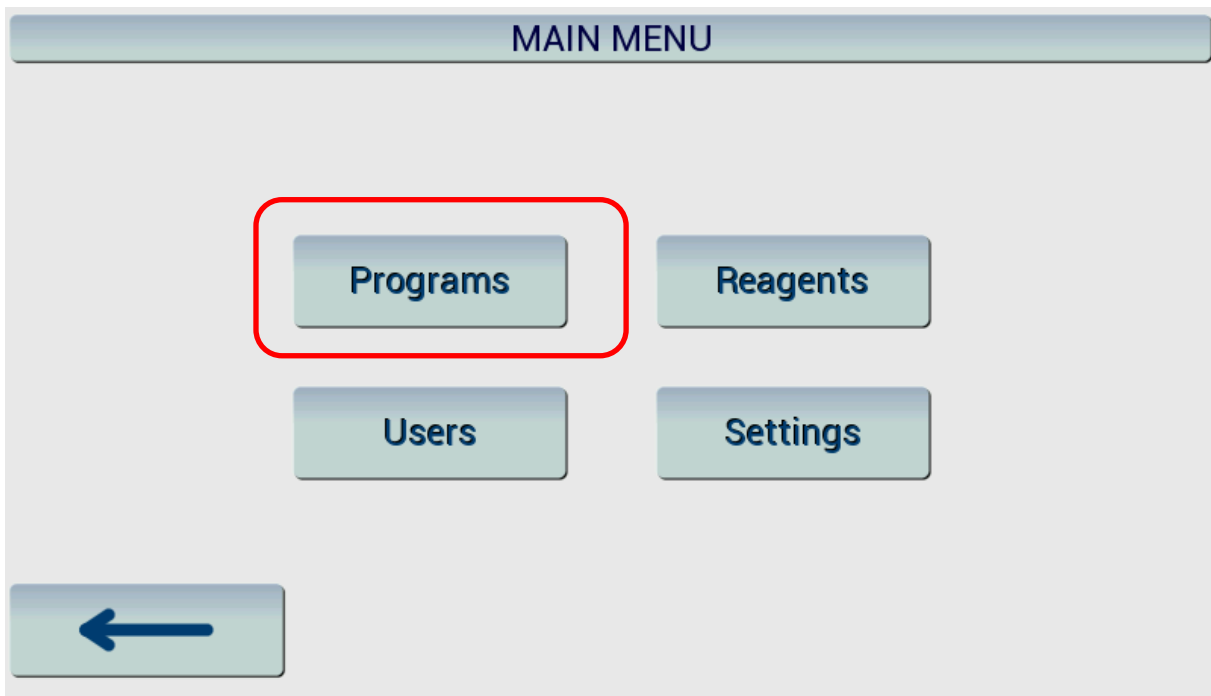

Please press "Programs" to find the list of programs or to select a new one.

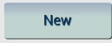

With the magnifier  you can edit an existing program. With the button  you can program a new one.

After pressing "New" in the "program selection" menu you see the following:



While pressing "Change" behind Short name you can insert the requested details (Short name is the name of the program to be seen in the overview):

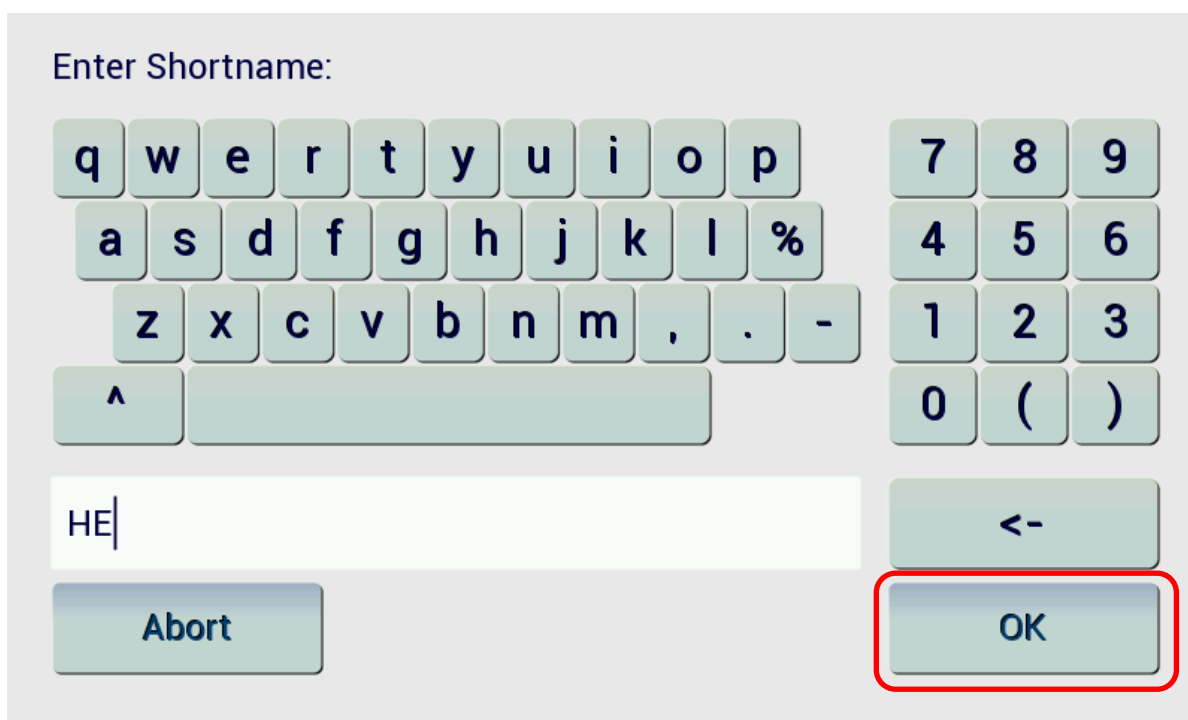

Please confirm every step with the “OK” button and to return to the menu “Program details”.



PROGRAM DETAILS

Shortname: HE1 Change

Name: HE1 Change

Driponff time: 5 Change

Total duration: 0:15:00 Steps

RMS: OFF

Abort Clear Save as new Save

While pressing “Change” behind Name you can insert the requested details (Name is the long version of the name of the program to be seen in the overview):

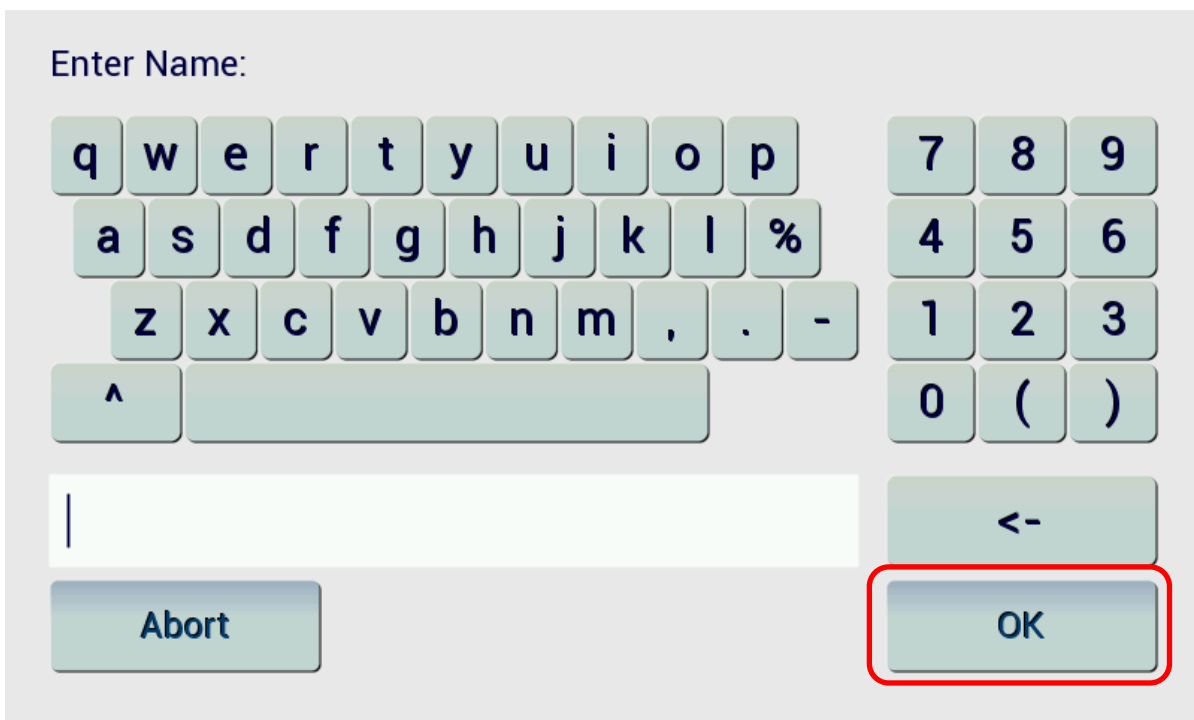

Enter Name:

q w e r t y u i o p 7 8 9

a s d f g h j k l % 4 5 6

z x c v b n m , . - 1 2 3

^ 0 ()

| <-

Abort OK

Please confirm every step with the “OK” button and to return to the menu “program details”.



While pressing "Change" behind Drip-off time you can select the time the basket may take out of the last cuvette for dripping of the reagent.

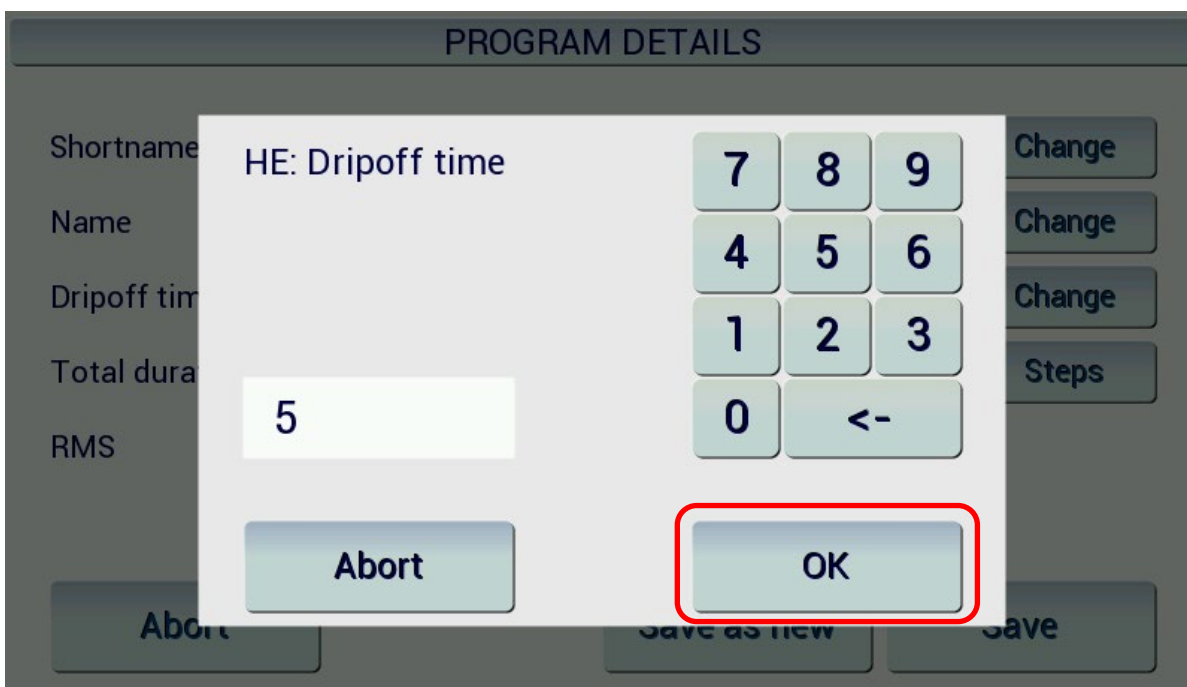

You can select from 0 – 250. Please confirm every step with the "OK" button and to return to the menu "program details".

PROGRAM DETAILS

Shortname	<input type="text" value="HE1"/>	<input type="button" value="Change"/>
Name	<input type="text" value="HE1"/>	<input type="button" value="Change"/>
Dripoff time	<input type="text" value="5"/>	<input type="button" value="Change"/>
Total duration	<input type="text" value="0:15:00"/>	<input style="border: 2px solid red;" type="button" value="Steps"/>
RMS	<input type="checkbox"/> OFF	

While pressing "Steps" behind Total duration you can select the step time and reagent.

HE: STEP 1

Reagent	<input type="text" value="AQUA"/>	<input style="border: 2px solid red;" type="button" value="Change"/>
Duration	<input type="text" value="0:30"/>	<input type="button" value="Change"/>

Please press "Change" behind reagent to select the reagent out of the below list.

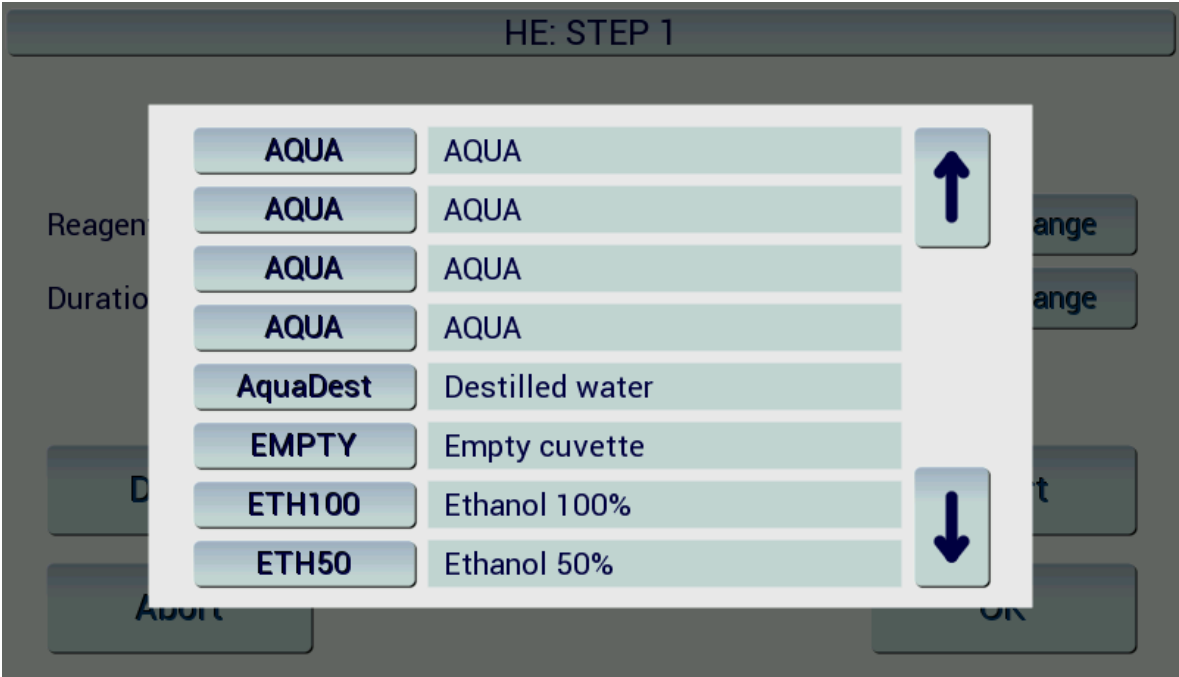

Please press "Change" behind Duration to select the incubation time.

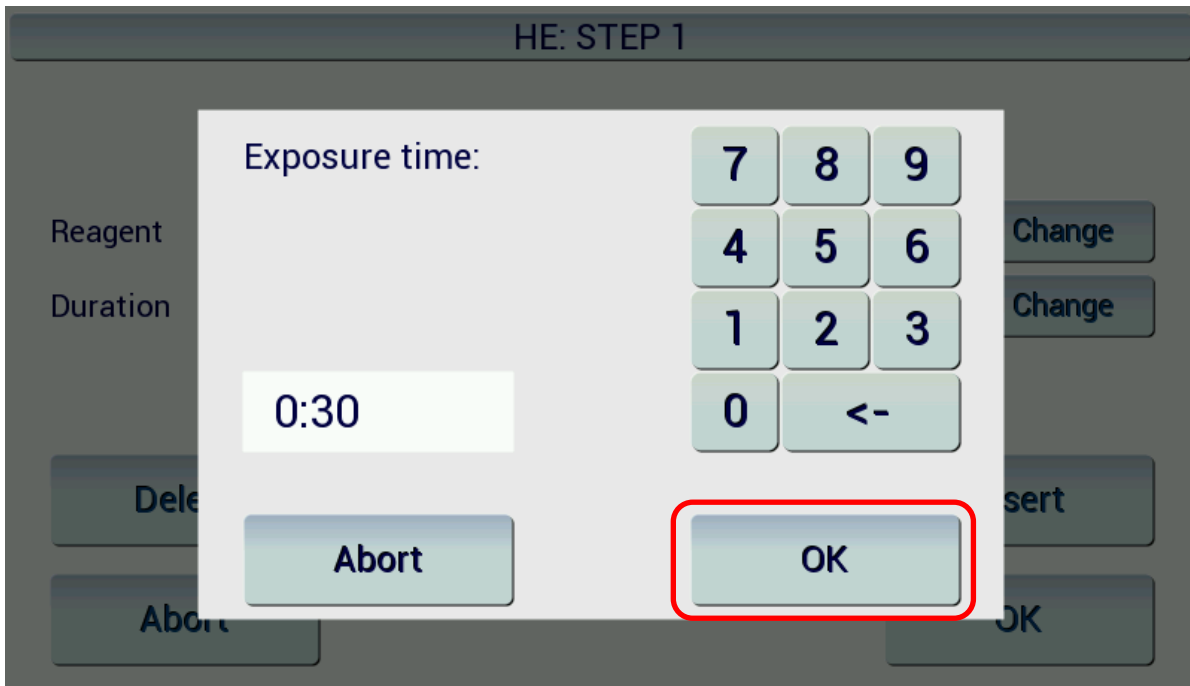

Please confirm your selection by pressing the OK button.

HE: PROGRAM STEPS					
No.	Reagent	Duration	RMS	RQ	Show
1	Empty cuvette	0:30	OFF		
2	Empty cuvette	0:30	OFF		
3	Empty cuvette	0:30	OFF		
4	Empty cuvette	0:30	OFF		
5	Empty cuvette	0:30	OFF		
6	Empty cuvette	0:30	OFF		
7	Empty cuvette	0:30	OFF		

Navigation arrows: a large blue arrow pointing up on the right side, a large blue arrow pointing down on the right side, and a large blue arrow pointing left at the bottom left.

Please repeat the step, described under 4.3.1 for every step (bath).



Please note that the cromatec II can only work step by step. No station can be shipped. If a station has no reagent it has to be marked as empty.

4.4 Users

4.4.1 Edit a new or existing user

Please follow the below instructions to save a new user or to edit an existing user.

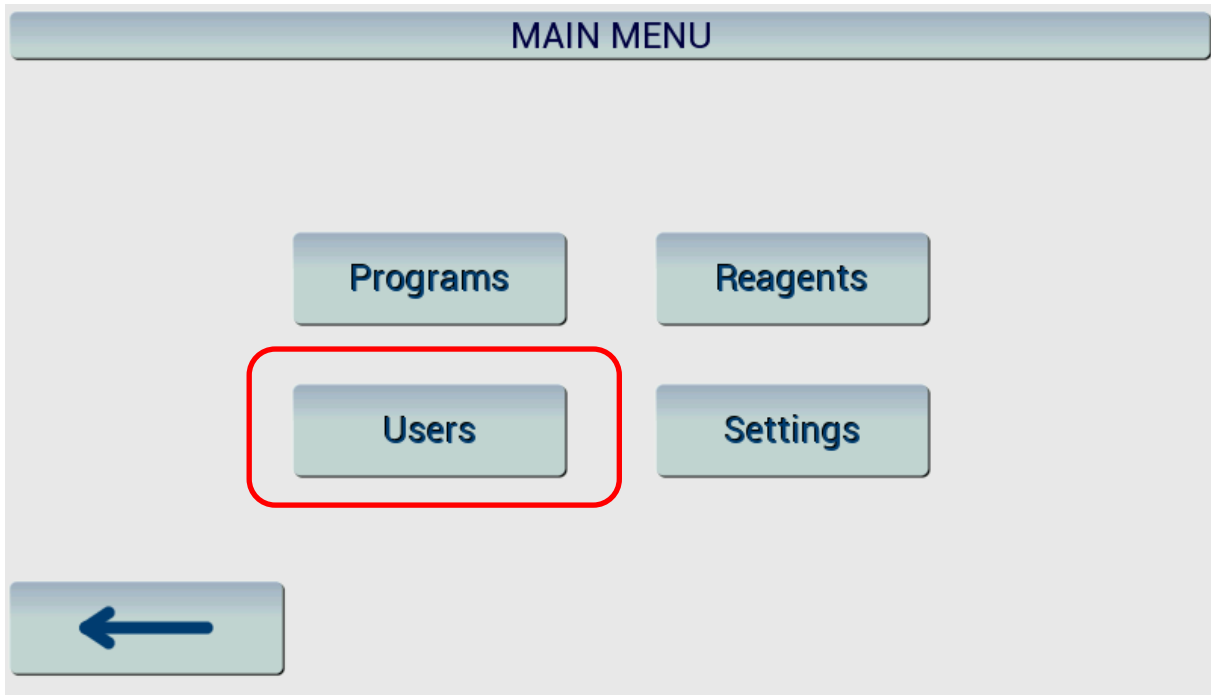

If you want to add or select a new user please press "Users" in main menu.

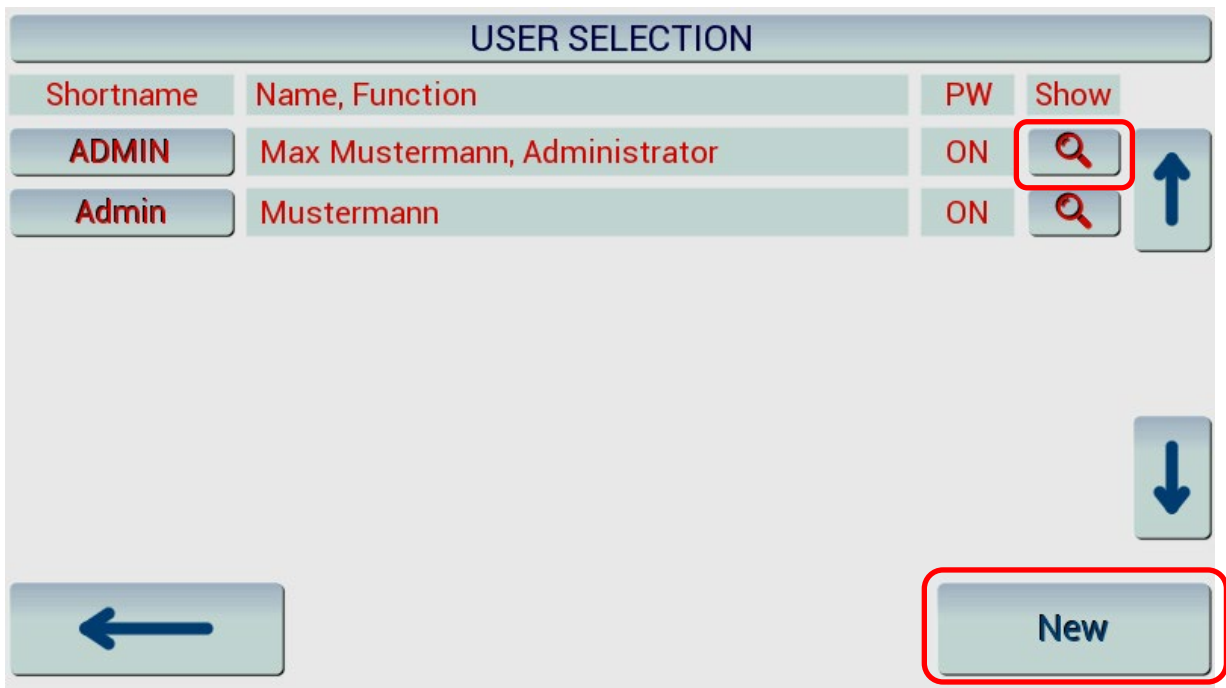

With the magnifier you can change the values of the user. If you want to add a user please press "New".

USER DETAILS

Shortname	<input type="text" value="Admin"/>	<input type="button" value="Change"/>
Name, Function	<input type="text" value="Mustermann"/>	<input type="button" value="Change"/>
Password	<input type="password" value="*****"/>	<input type="button" value="Change"/>
Admin	<input checked="" type="checkbox" value="YES"/>	

Press "Change" behind Short name to enter the Short name of the user.

Enter Shortname:

<table style="width: 100%; border-collapse: collapse;"> <tr> <td style="padding: 2px 5px;">q</td><td style="padding: 2px 5px;">w</td><td style="padding: 2px 5px;">e</td><td style="padding: 2px 5px;">r</td><td style="padding: 2px 5px;">t</td><td style="padding: 2px 5px;">y</td><td style="padding: 2px 5px;">u</td><td style="padding: 2px 5px;">i</td><td style="padding: 2px 5px;">o</td><td style="padding: 2px 5px;">p</td> <td style="padding: 2px 5px;">7</td><td style="padding: 2px 5px;">8</td><td style="padding: 2px 5px;">9</td> </tr> <tr> <td style="padding: 2px 5px;">a</td><td style="padding: 2px 5px;">s</td><td style="padding: 2px 5px;">d</td><td style="padding: 2px 5px;">f</td><td style="padding: 2px 5px;">g</td><td style="padding: 2px 5px;">h</td><td style="padding: 2px 5px;">j</td><td style="padding: 2px 5px;">k</td><td style="padding: 2px 5px;">l</td><td style="padding: 2px 5px;">%</td> <td style="padding: 2px 5px;">4</td><td style="padding: 2px 5px;">5</td><td style="padding: 2px 5px;">6</td> </tr> <tr> <td style="padding: 2px 5px;">z</td><td style="padding: 2px 5px;">x</td><td style="padding: 2px 5px;">c</td><td style="padding: 2px 5px;">v</td><td style="padding: 2px 5px;">b</td><td style="padding: 2px 5px;">n</td><td style="padding: 2px 5px;">m</td><td style="padding: 2px 5px;">,</td><td style="padding: 2px 5px;">.</td><td style="padding: 2px 5px;">-</td> <td style="padding: 2px 5px;">1</td><td style="padding: 2px 5px;">2</td><td style="padding: 2px 5px;">3</td> </tr> <tr> <td style="padding: 2px 5px;">^</td><td colspan="9"></td> <td style="padding: 2px 5px;">0</td><td style="padding: 2px 5px;">(</td><td style="padding: 2px 5px;">)</td> </tr> </table>	q	w	e	r	t	y	u	i	o	p	7	8	9	a	s	d	f	g	h	j	k	l	%	4	5	6	z	x	c	v	b	n	m	,	.	-	1	2	3	^										0	()	
q	w	e	r	t	y	u	i	o	p	7	8	9																																									
a	s	d	f	g	h	j	k	l	%	4	5	6																																									
z	x	c	v	b	n	m	,	.	-	1	2	3																																									
^										0	()																																									
<input style="width: 100%;" type="text" value="Admin"/>	<input type="button" value="<-"/>																																																				
<input type="button" value="Abort"/>	<input type="button" value="OK"/>																																																				

Please confirm with ok and to return to menu user details.

USER DETAILS

Shortname	<input type="text" value="Admin"/>	<input type="button" value="Change"/>
Name, Function	<input type="text" value="Mustermann"/>	<input type="button" value="Change"/>
Password	<input type="text" value="*****"/>	<input type="button" value="Change"/>
Admin	<input checked="" type="radio" value="YES"/>	

Press change behind Name, Function to enter the Name and Function or Department of the user.

Enter Name and Function:

q	w	e	r	t	y	u	i	o	p	7	8	9	
a	s	d	f	g	h	j	k	l	%	4	5	6	
z	x	c	v	b	n	m	,	.	-	1	2	3	
^											0	()

Please confirm with ok and to return to menu user details.

USER DETAILS

Shortname	<input type="text" value="Admin"/>	<input type="button" value="Change"/>
Name, Function	<input type="text" value="Mustermann"/>	<input type="button" value="Change"/>
Password	<input type="password" value="*****"/>	<input style="border: 2px solid red;" type="button" value="Change"/>
Admin	<input checked="" type="radio" value="YES"/>	

Press change behind Password to change the password. If <none> is selected, there is no password active.

Enter new password:

<table style="width: 100%; border-collapse: collapse;"> <tr><td>q</td><td>w</td><td>e</td><td>r</td><td>t</td><td>y</td><td>u</td><td>i</td><td>o</td><td>p</td></tr> <tr><td>a</td><td>s</td><td>d</td><td>f</td><td>g</td><td>h</td><td>j</td><td>k</td><td>l</td><td>%</td></tr> <tr><td>z</td><td>x</td><td>c</td><td>v</td><td>b</td><td>n</td><td>m</td><td>,</td><td>.</td><td>-</td></tr> <tr><td>^</td><td colspan="9"></td></tr> </table>	q	w	e	r	t	y	u	i	o	p	a	s	d	f	g	h	j	k	l	%	z	x	c	v	b	n	m	,	.	-	^										<table style="width: 100%; border-collapse: collapse;"> <tr><td>7</td><td>8</td><td>9</td></tr> <tr><td>4</td><td>5</td><td>6</td></tr> <tr><td>1</td><td>2</td><td>3</td></tr> <tr><td>0</td><td>(</td><td>)</td></tr> <tr><td colspan="3" style="text-align: center;"><input type="button" value="←"/></td></tr> </table>	7	8	9	4	5	6	1	2	3	0	()	<input type="button" value="←"/>		
q	w	e	r	t	y	u	i	o	p																																															
a	s	d	f	g	h	j	k	l	%																																															
z	x	c	v	b	n	m	,	.	-																																															
^																																																								
7	8	9																																																						
4	5	6																																																						
1	2	3																																																						
0	()																																																						
<input type="button" value="←"/>																																																								

Please confirm with ok and to return to menu user details.

USER DETAILS

Shortname	<input type="text" value="Admin"/>	<input type="button" value="Change"/>
Name, Function	<input type="text" value="Mustermann"/>	<input type="button" value="Change"/>
Password	<input type="password" value="*****"/>	<input type="button" value="Change"/>
Admin	<input checked="" type="radio" value="YES"/>	

Please confirm everything with save and to return to menu user selection.

USER SELECTION

Shortname	Name, Function	PW	Show	
<input type="button" value="ADMIN"/>	Max Mustermann, Administrator	ON	<input type="button" value="🔍"/>	<input type="button" value="↑"/>
<input type="button" value="Admin"/>	Mustermann	ON	<input type="button" value="🔍"/>	

With the arrow you can return to the main menu.

4.5 Reagents

4.5.1 Edit or create a new reagent

Please follow the below instructions to save a new reagent or to edit an existing reagent

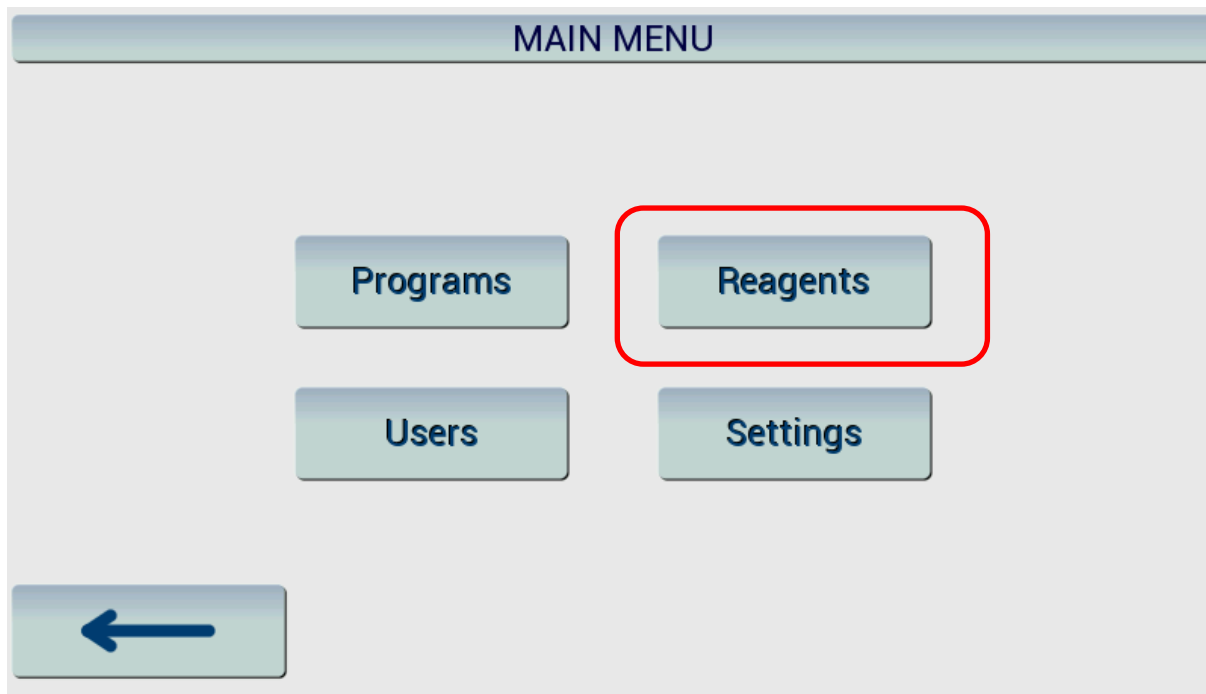

If you want to add or select a new reagent please press "Reagents" in main menu.

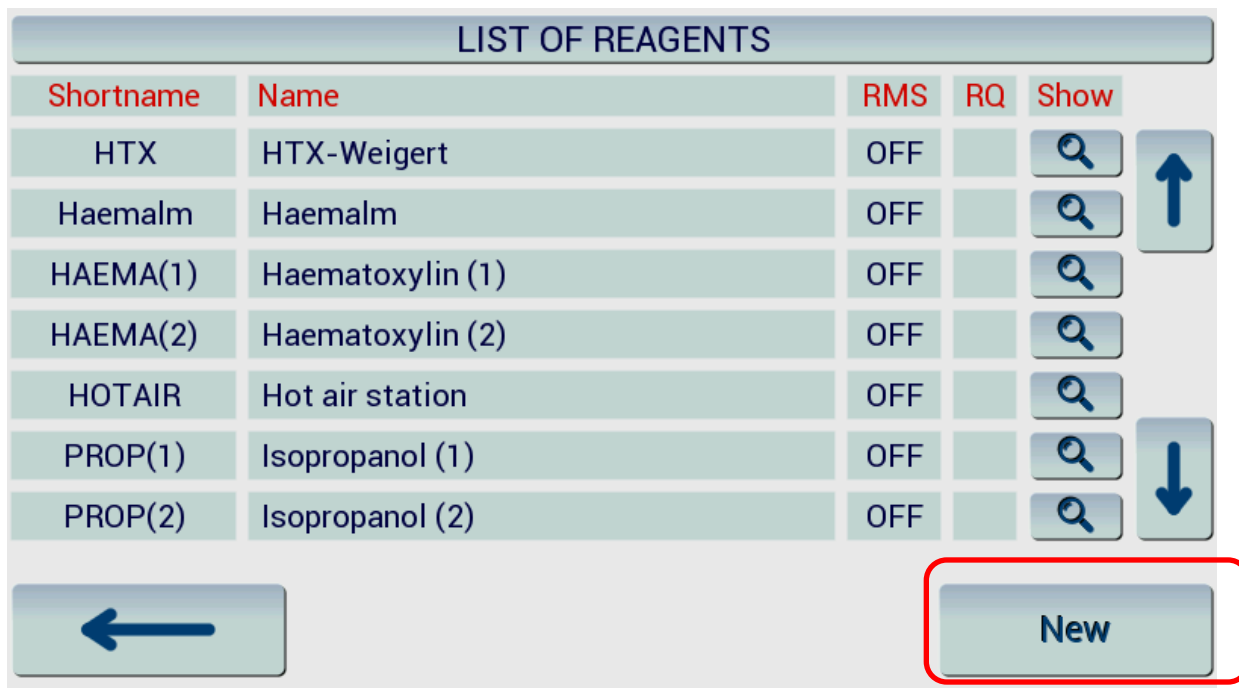

With the magnifier you can adjust an existing reagent or with "New" you can add a new one.

REAGENT DETAILS

Shortname	<input type="text"/>	<input type="button" value="Change"/>
Name	<input type="text"/>	<input type="button" value="Change"/>
RMS	<input type="radio"/> OFF	
Max. Days	<input type="text" value="10"/> Used: 0 - 100% remaining	<input type="button" value="Change"/>
Max. Runs	<input type="text" value="10"/> Used: 0 - 100% remaining	<input type="button" value="Change"/>
Replaced	<input type="text" value="<unknown>"/>	<input type="button" value="Replace"/>

Enter Shortname:

<input type="button" value="q"/> <input type="button" value="w"/> <input type="button" value="e"/> <input type="button" value="r"/> <input type="button" value="t"/> <input type="button" value="y"/> <input type="button" value="u"/> <input type="button" value="i"/> <input type="button" value="o"/> <input type="button" value="p"/>	<input type="button" value="7"/> <input type="button" value="8"/> <input type="button" value="9"/>
<input type="button" value="a"/> <input type="button" value="s"/> <input type="button" value="d"/> <input type="button" value="f"/> <input type="button" value="g"/> <input type="button" value="h"/> <input type="button" value="j"/> <input type="button" value="k"/> <input type="button" value="l"/> <input type="button" value="%"/>	<input type="button" value="4"/> <input type="button" value="5"/> <input type="button" value="6"/>
<input type="button" value="z"/> <input type="button" value="x"/> <input type="button" value="c"/> <input type="button" value="v"/> <input type="button" value="b"/> <input type="button" value="n"/> <input type="button" value="m"/> <input type="button" value=","/> <input type="button" value="."/> <input type="button" value="-"/>	<input type="button" value="1"/> <input type="button" value="2"/> <input type="button" value="3"/>
<input type="button" value="^"/> <input style="width: 300px; height: 20px;" type="text"/>	<input type="button" value="0"/> <input type="button" value("(""=""/> <input type="button" value=")"/>

Enter Name:

q	w	e	r	t	y	u	i	o	p	7	8	9
a	s	d	f	g	h	j	k	l	%	4	5	6
z	x	c	v	b	n	m	,	.	-	1	2	3
^										0	()
										<-		
Abort										OK		

REAGENT DETAILS			
Shortname	<input type="text"/>		Change
Name	<input type="text"/>		Change
RMS	<input checked="" type="checkbox"/> ON		
Max. Days	<input type="text" value="10"/>	Used: 0 - 100% remaining	Change
Max. Runs	<input type="text" value="10"/>	Used: 0 - 100% remaining	Change
Replaced	<input type="text" value="<unknown>"/>		Replace
Abort		Clear	Save



RMS stands for Reagent Management and shows visually on the main screen to what extent a reagent has already been used. Furthermore, the upper and maximum uses can be defined. When the reagent has been replaced, simply press the "Replace" button and the counter starts again.

REAGENT DETAILS

Shortname Change

Name Change

RMS OFF

Max. Days Used: 0 - 100% remaining Change

Max. Runs Used: 0 - 100% remaining Change

Replaced Replace

Abort
Clear
Save

REAGENT DETAILS

Shortname Change

Name Change

RMS OFF

Max. Days Used: 0 - 100% remaining Change

Max. Runs Used: 0 - 100% remaining Change

Replaced Replace

Abort
Clear
Save

Max. Days

7	8	9
4	5	6
1	2	3
0	<-	

Abort
OK

REAGENT DETAILS

Shortname	Max. Runs	7	8	9	Change
Name		4	5	6	Change
RMS		1	2	3	Change
Max. Days	10	0	<-		Change
Max. Runs					Replace
Replaced	Abort				Save

Abort **OK**

4.5.2 Edit / select hot air station – only Cromatec II

LIST OF REAGENTS				
Shortname	Name	RMS	RQ	Show
HTX	HTX-Weigert	OFF		
Haemalm	Haemalm	OFF		
HAEMA(1)	Haematoxylin (1)	OFF		
HAEMA(2)	Haematoxylin (2)	OFF		
HOTAIR	Hot air station	OFF		
PROP(1)	Isopropanol (1)	OFF		
PROP(2)	Isopropanol (2)	OFF		

Navigation buttons: Left arrow, New, Up arrow, Down arrow.

REAGENT DETAILS	
Shortname	<input type="text" value="HOTAIR"/> Change
Name	<input type="text" value="Hot air station"/> Change
RMS	<input type="radio"/> OFF
Max. Days	<input type="text" value="0"/> Used: 0 - 0% remaining Change
Max. Runs	<input type="text" value="0"/> Used: 0 - 0% remaining Change
Replaced	<input type="text" value="<unknown>"/> Replace
Abort Clear OK	



Please note that the option Hot air station is preinstalled (if option has been choosed) and no changes can be done in the reagent details.



Drying station can only be selected as station 1 or 20. The agitation is then switched off.

4.6 Settings

4.6.1 Settings of the Cromatec

Please follow the below instructions to edit and save settings.

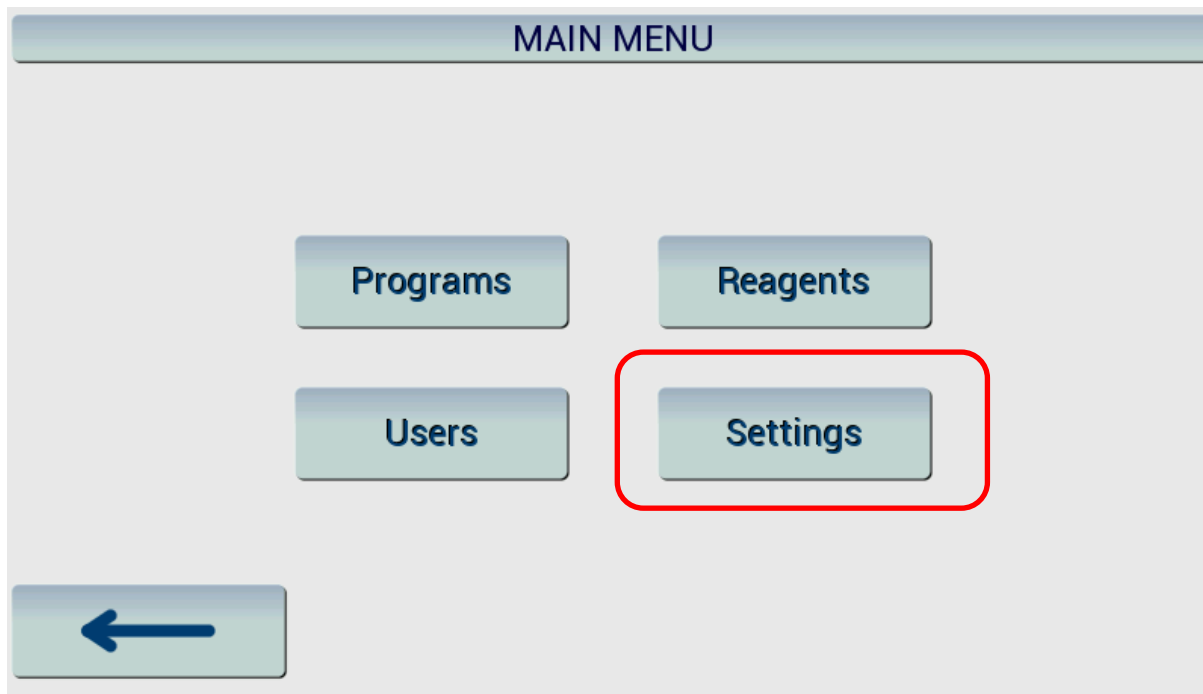

If you want to change the settings of the Cromatec please press "Settings" in main menu.

4.6.2 Agitation/Fan

To change the settings for agitation and fan please select "Agitation/Fan" in the Settings menu.

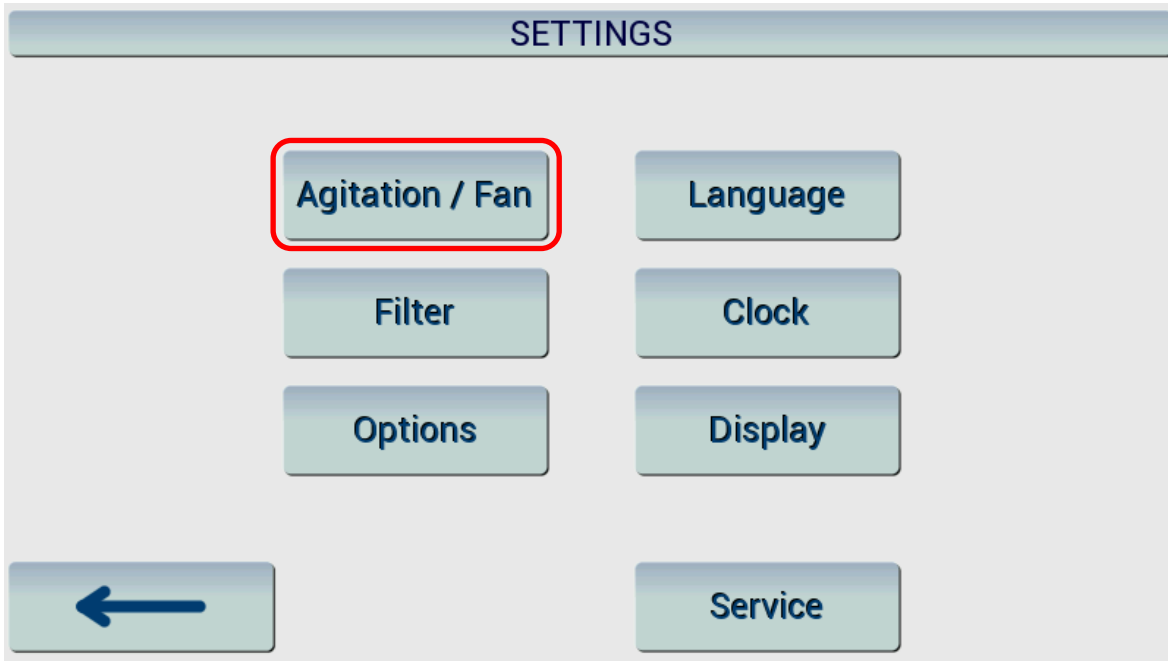

The agitation and fan speed can be changed in the menu. You can select between slow, normal and fast.

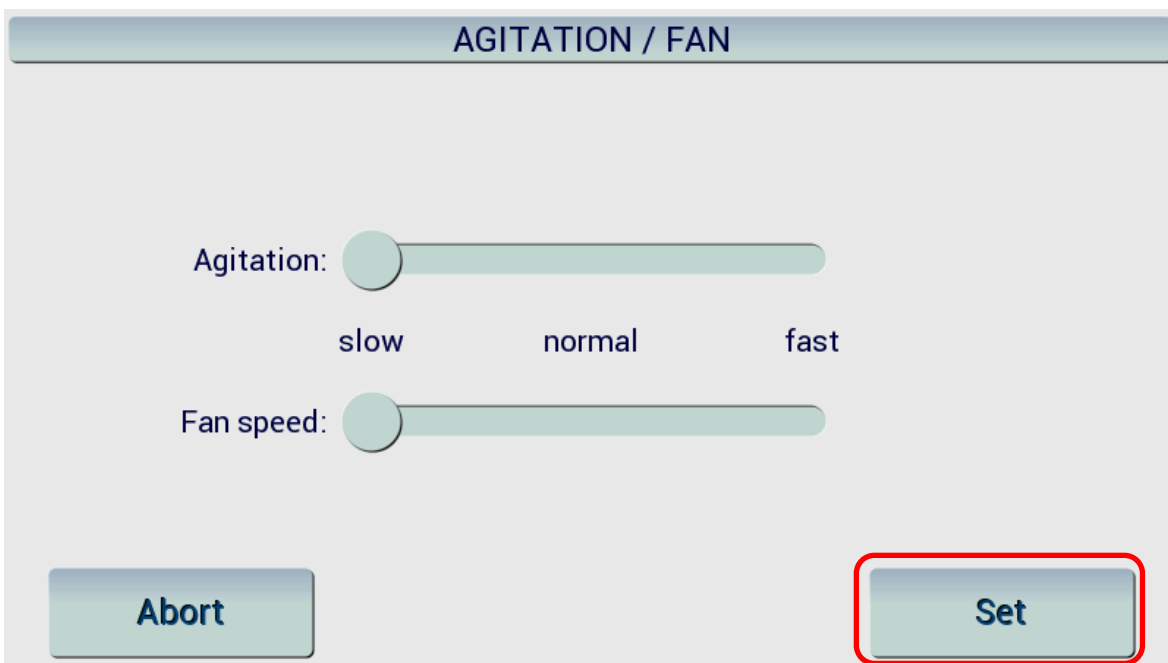

Please confirm your settings by pushing "Set".

4.6.3 Filter

To change the settings for the filter please select “Filter” in the Settings menu.

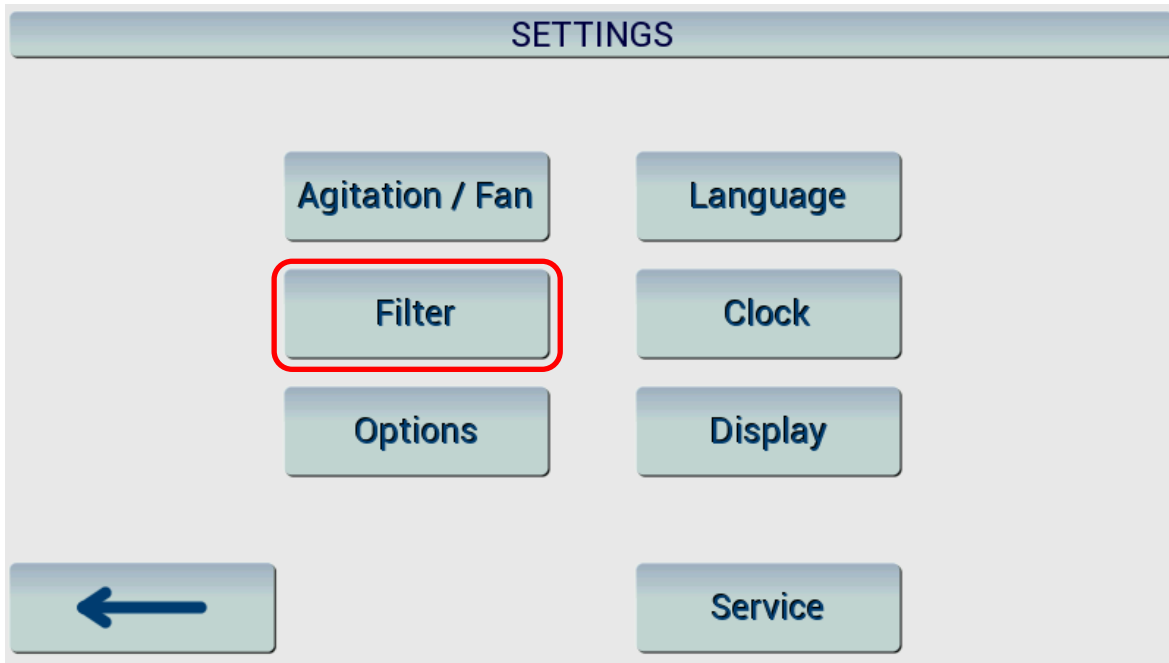

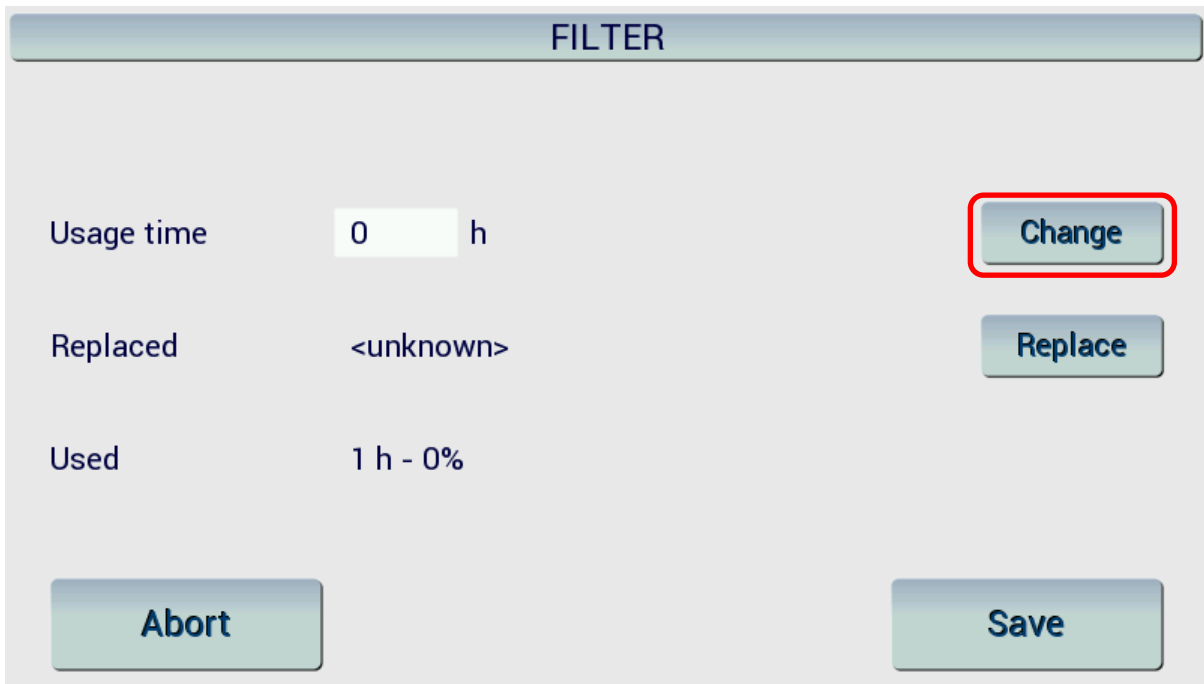

If you want to change the filter usage time please select "Change". Please adjust the values as follows.

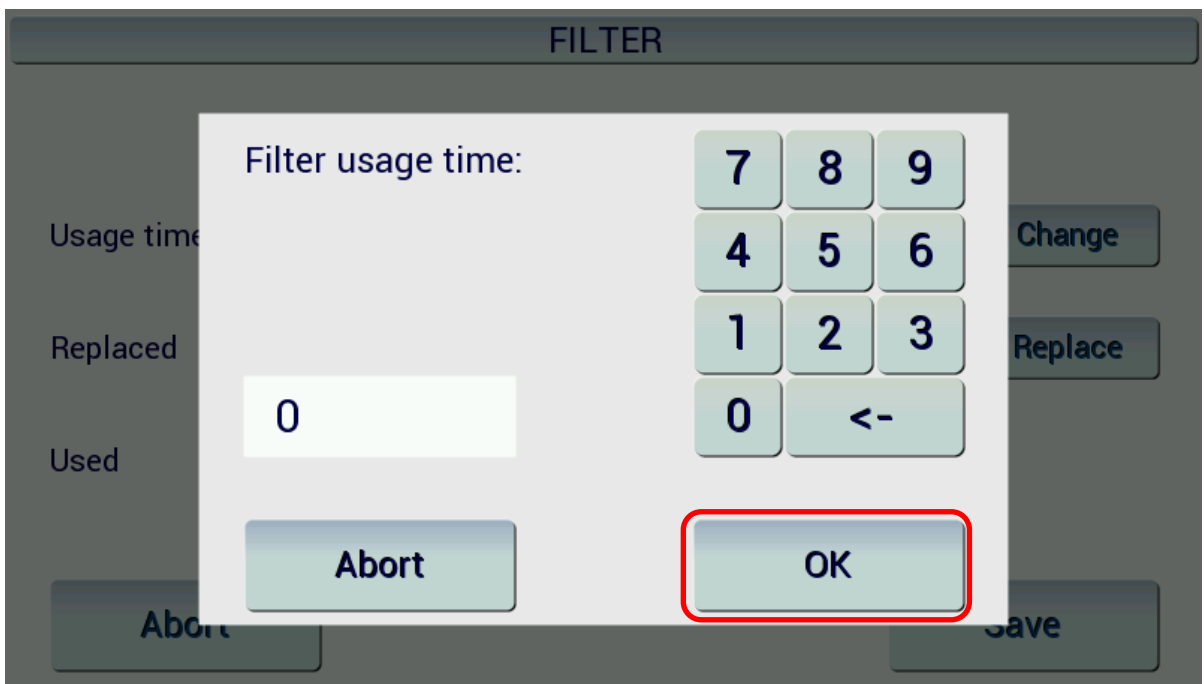

A value of 1000 hrs is default setting. You can select values from 1h to 9999 hrs. Please confirm your settings by pressing "OK".

FILTER		
Usage time	1000 h	<input type="button" value="Change"/>
Replaced	18.06.16 - 01:58	<input type="button" value="Replace"/>
Used	0 h - 0%	
<input type="button" value="Abort"/>		<input type="button" value="Save"/>

If you have replaced the filter, please press "Replace". The value shown under "Used" will be set to 0. (For filter exchange please refer to chapter 3.6)

FILTER		
Usage time	1000 h	<input type="button" value="Change"/>
Replaced	18.06.16 - 01:58	<input type="button" value="Replace"/>
Used	0 h - 0%	
<input type="button" value="Abort"/>		<input type="button" value="Save"/>

Please save your settings by pressing "Save".

4.6.4 Options – only Cromatec II

To change the settings for the temperature of hot air station please select “Options” in the Settings menu.

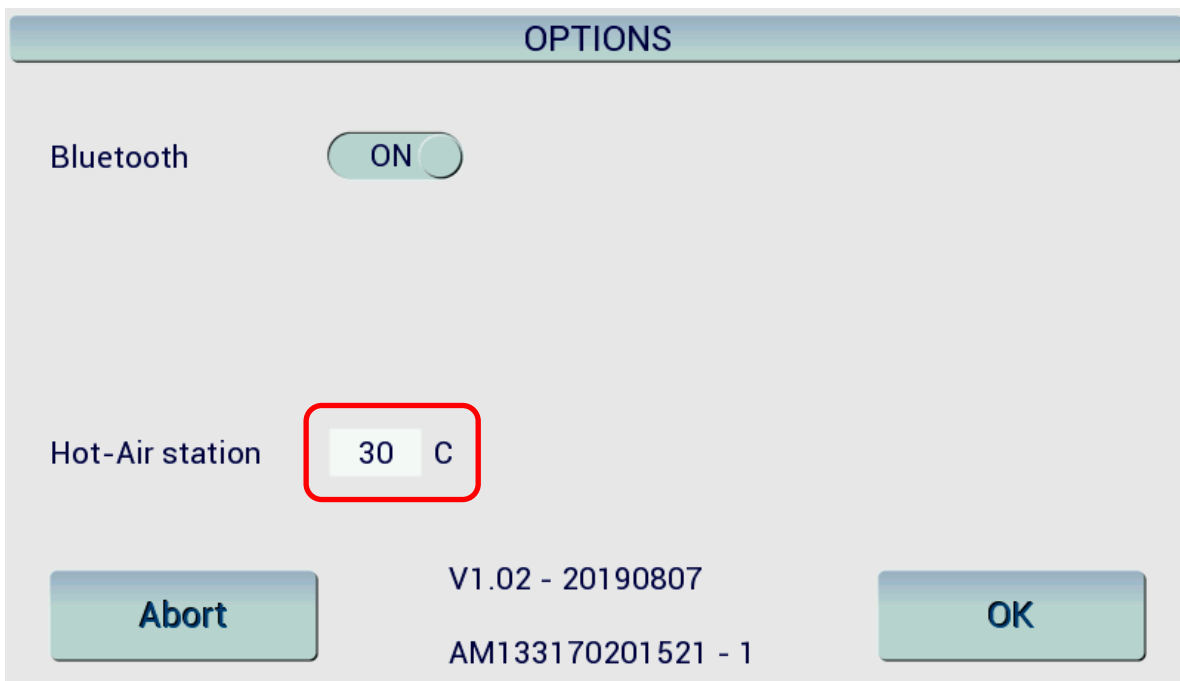
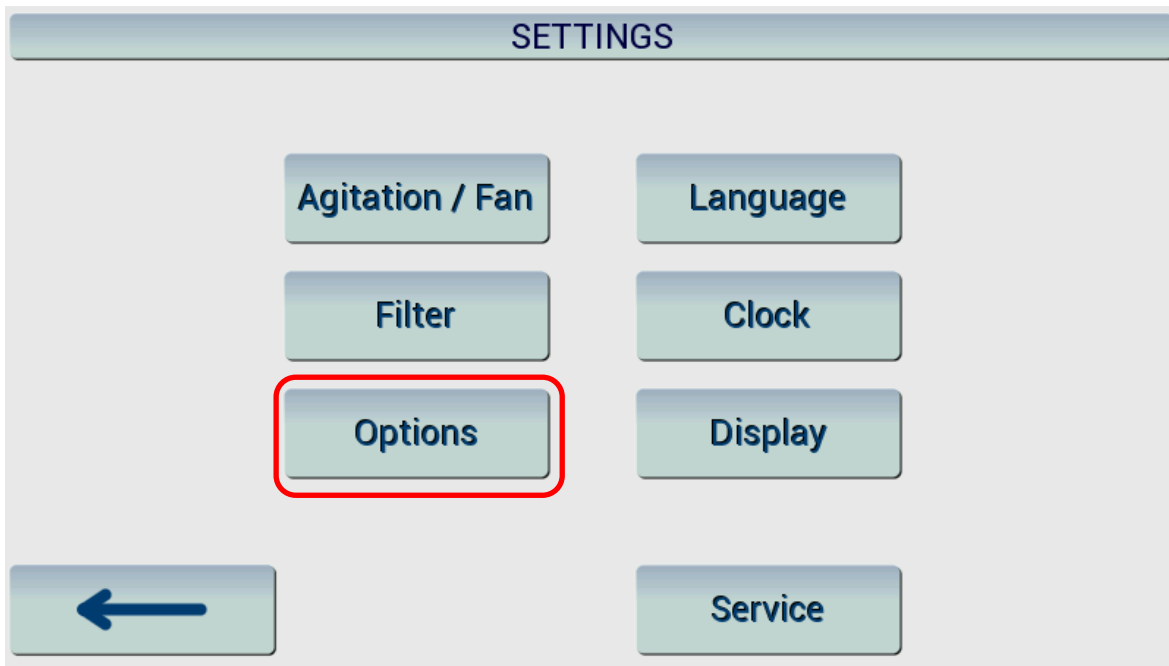

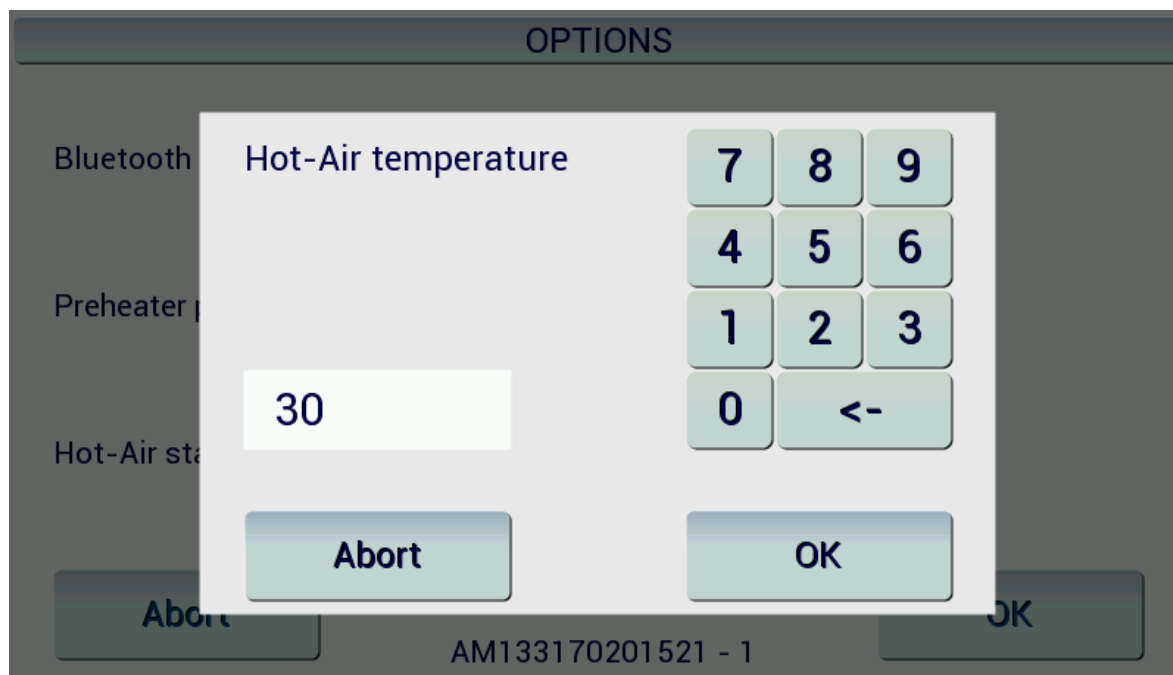

The hot-air station temperature can be selected between 30°C and 70°C. Please set the temperature and confirm with OK.

The melting of the paraffin on the samples is dependent on the temperature, number of glass slides in the slide baskets, and sample thickness. In addition, the heating cuvette needs a certain amount of time to warm up, which is automatically controlled by a small waiting time via the software. When using the heating cuvette, the program does not start until the set temperature has been reached.

The Bluetooth function can also be switched on and off here. Here you also can set the Bluetooth connection from ON to OFF.

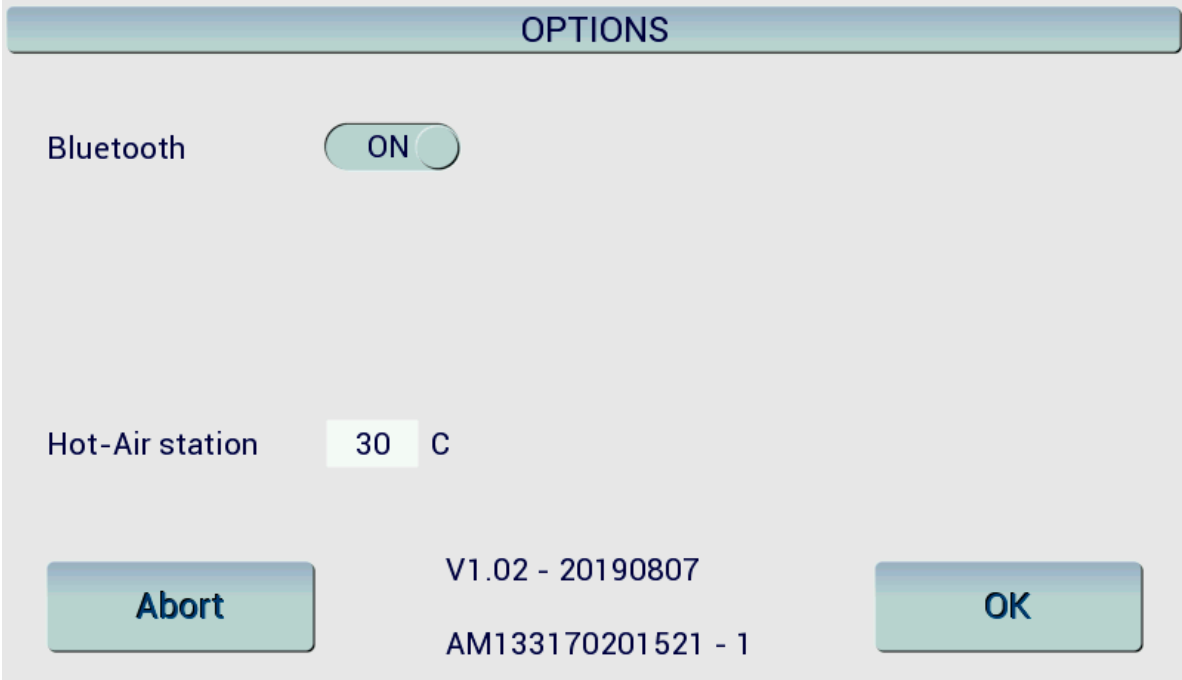
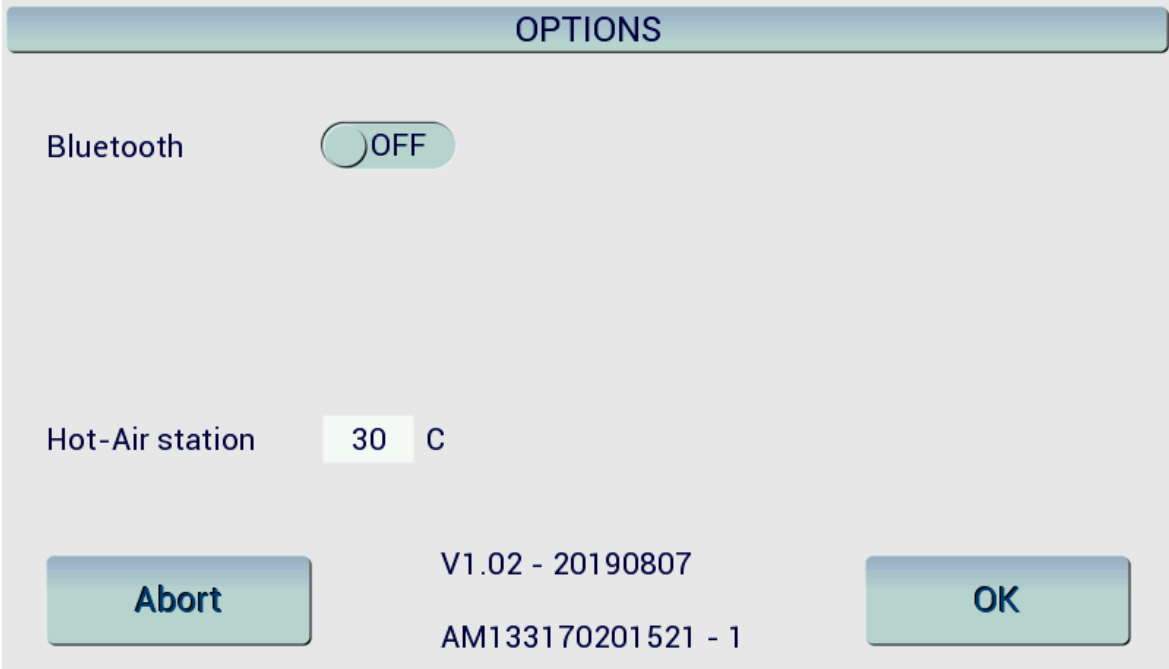

4.6.5 Language

To change the settings for the language options please select "Language" in the Settings menu.

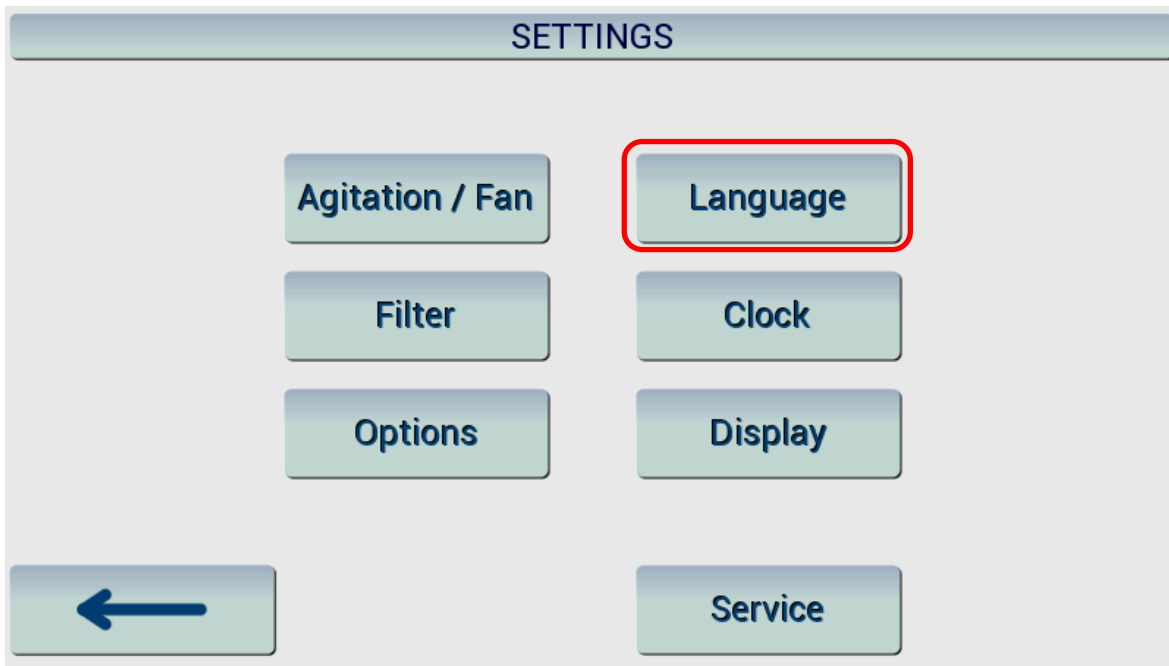

4.6.6 Time and date

To change the settings for time and date please select "Clock" in the Settings menu.

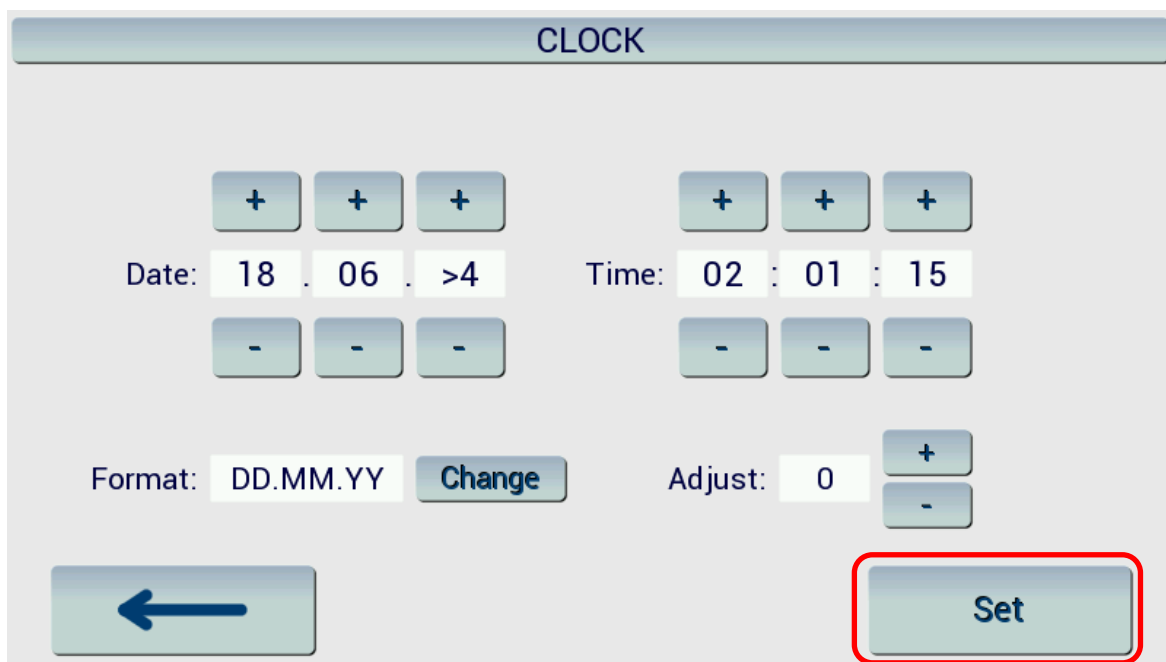
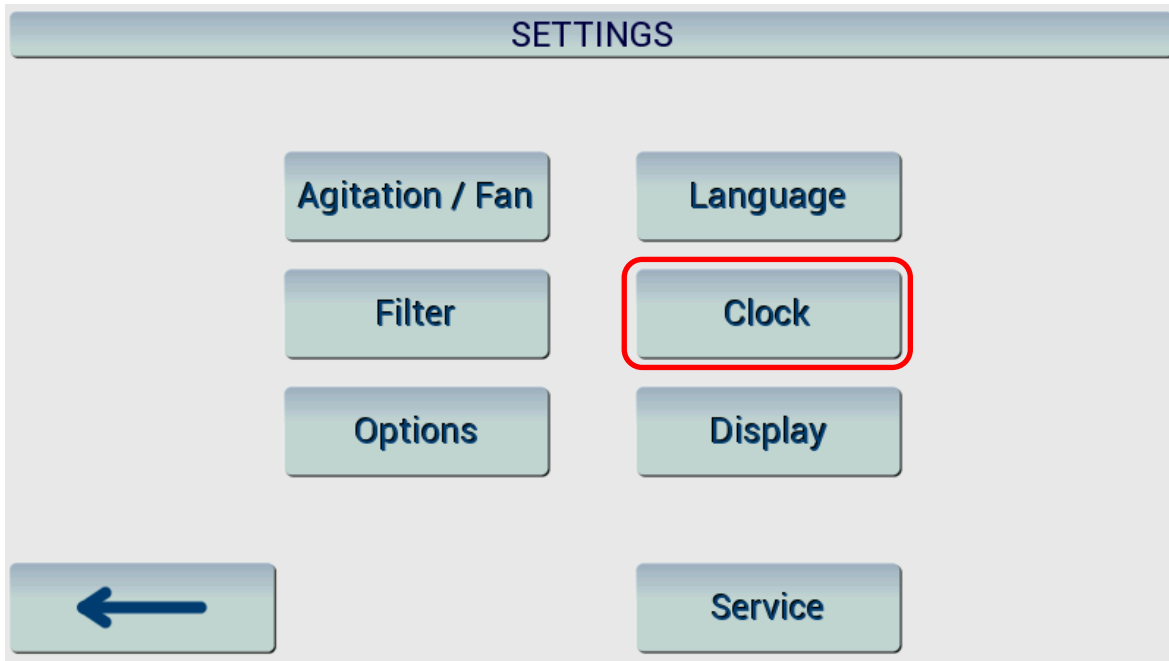

With + and – you can select the actual time and date. If you want to change the format of date please press "Change". Possible formats are: DD.MM.YY and MM.DD.YY. With adjust you can select differences between summer and wintertime.

After that please press "SET" for saving these settings and to return to settings menu and to main menu.

4.6.7 Display

To change the settings for the display please select "Display" in the Settings menu.

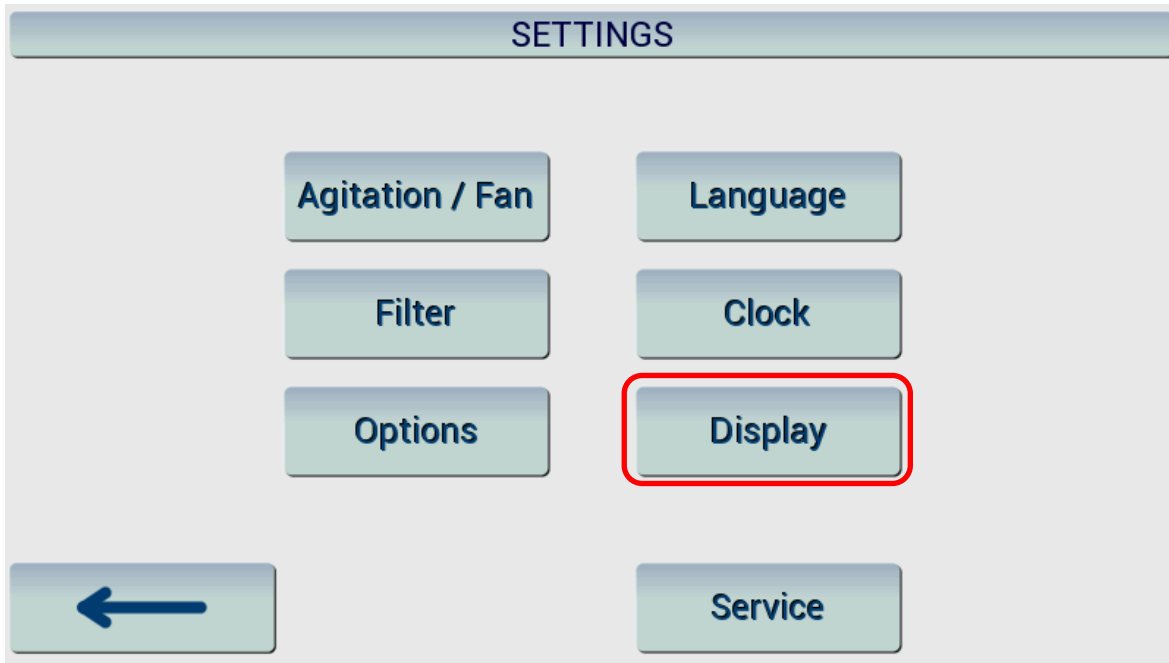

You can select the display brightness from 0 to 10. With the button "Key click" you switch on / off the key tones.

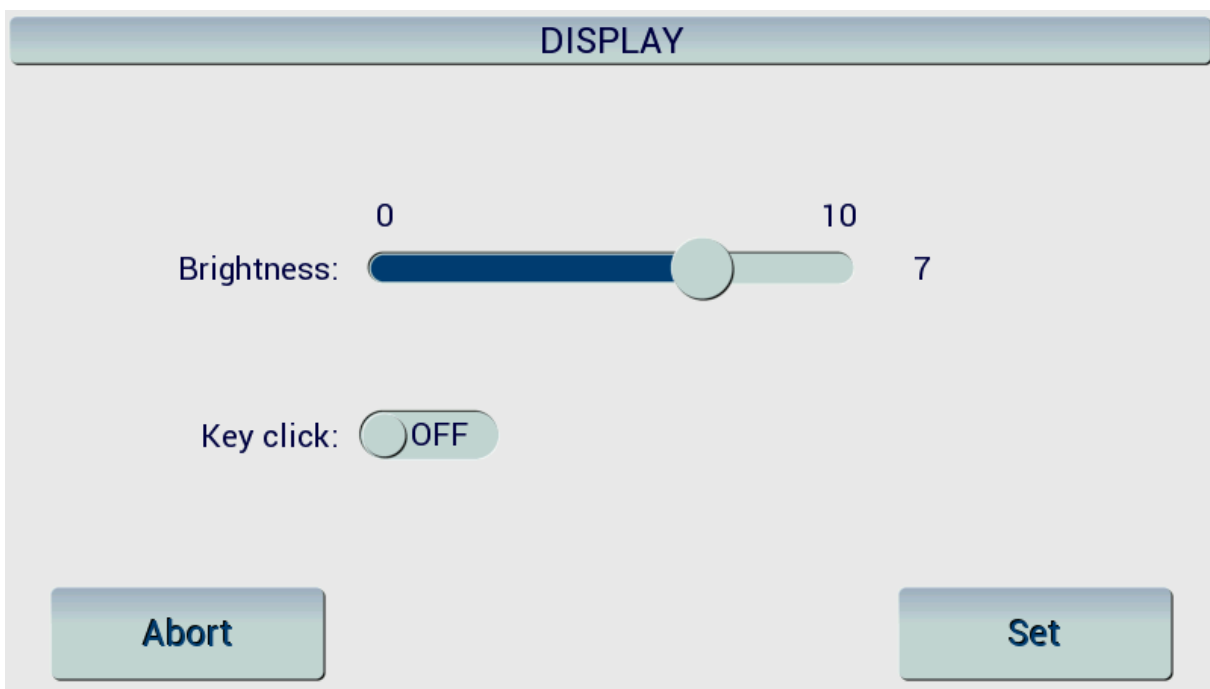

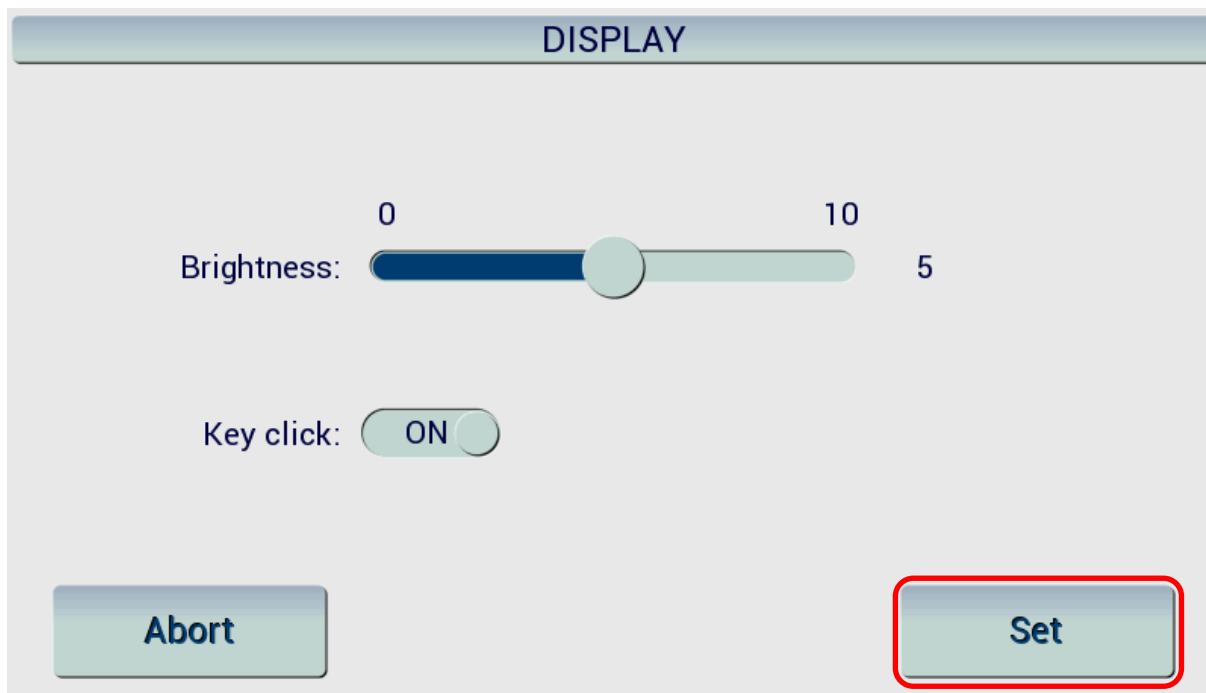

Please confirm your selection with set.

4.6.8 Service

To change the Service settings please select "Service" in the Settings menu.

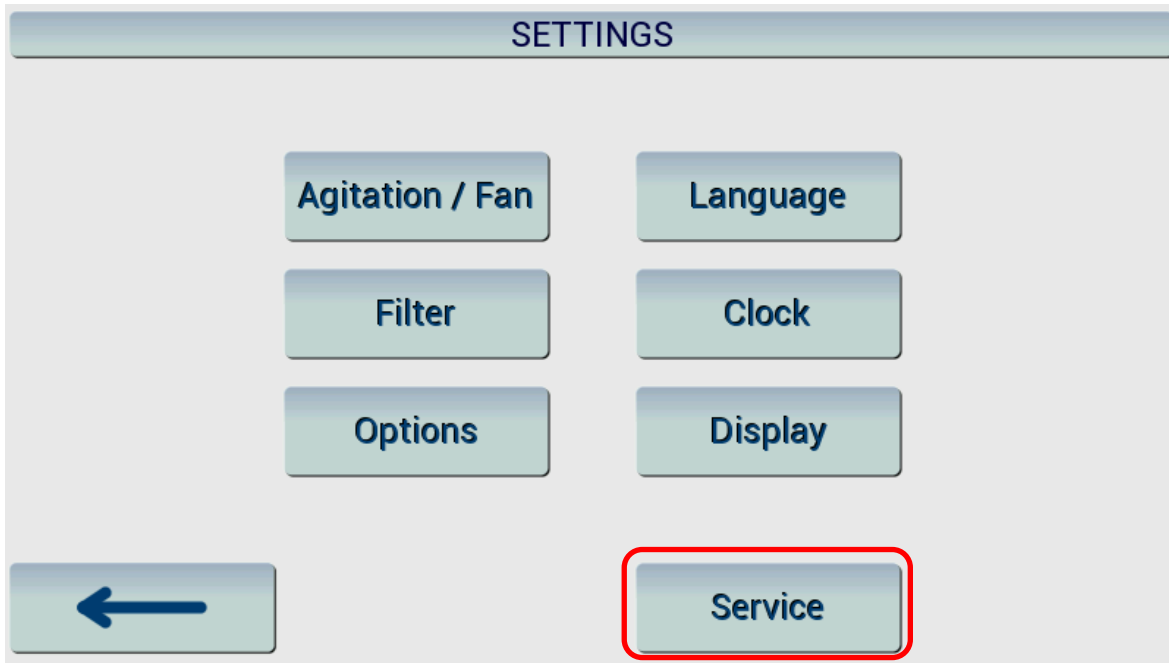

Service settings are password protected!

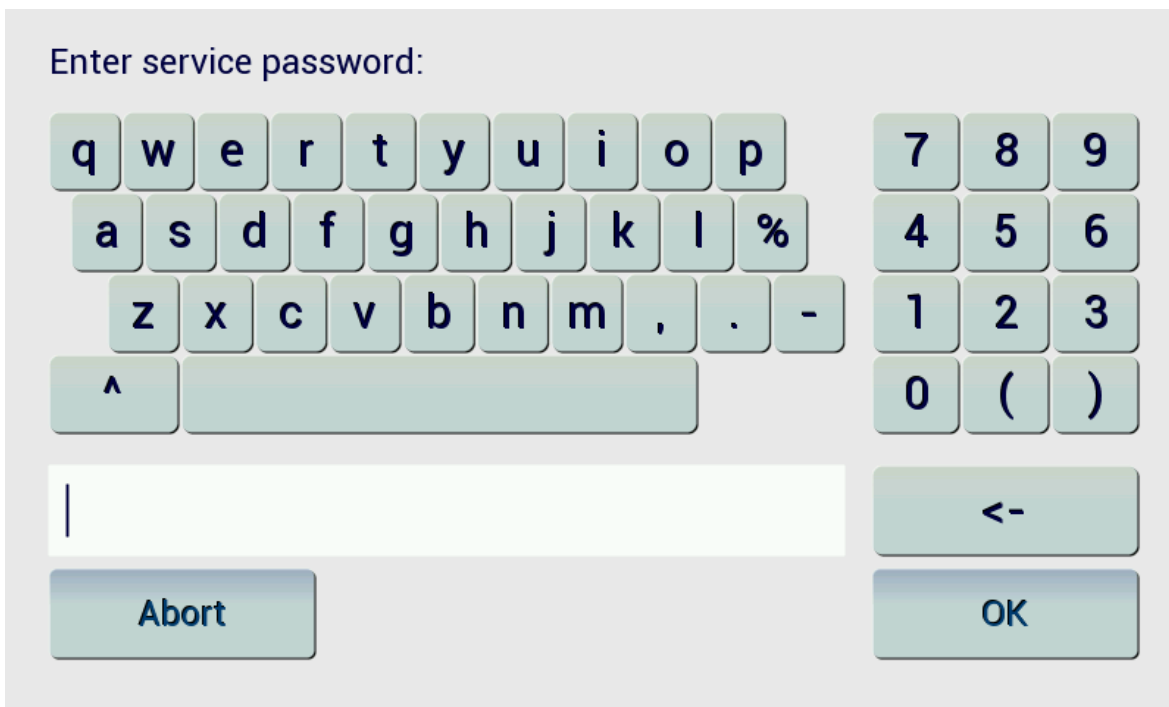

4.7 Run a staining program

4.7.1 Place slide baskets in the loading station

Please put the slide baskets you want to stain into the loading station. You can place up to 5 slide baskets into the loading station.



4.7.2 Select the program you want to stain

You can select the program you want to stain by pressing the current program.

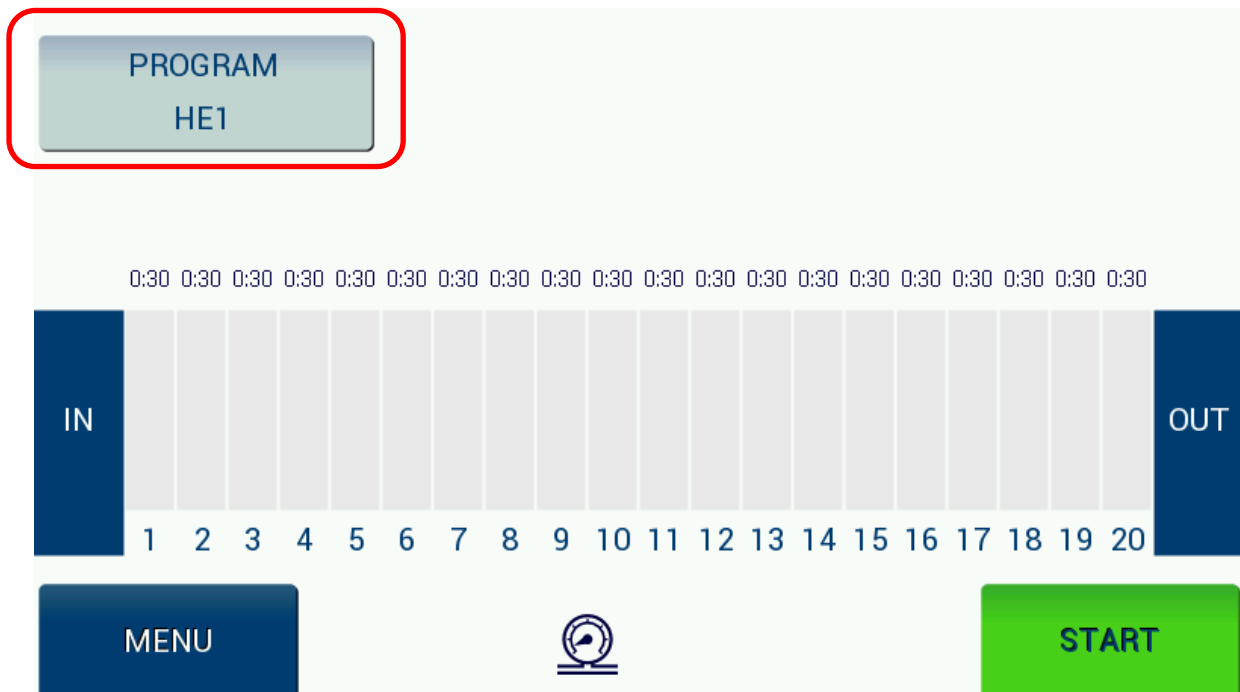

You will be taken to the Program Selection menu. Just click on the short name to choose the program.

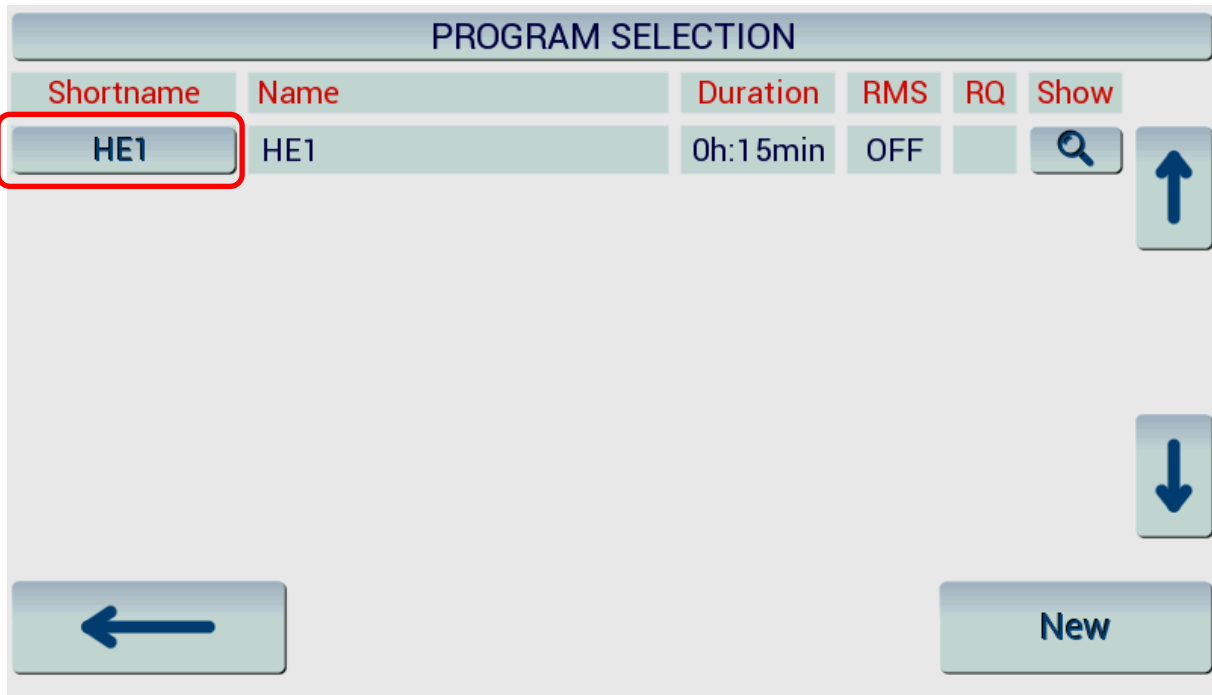

Once selected you will be back at the overview screen and the selected program is visible.

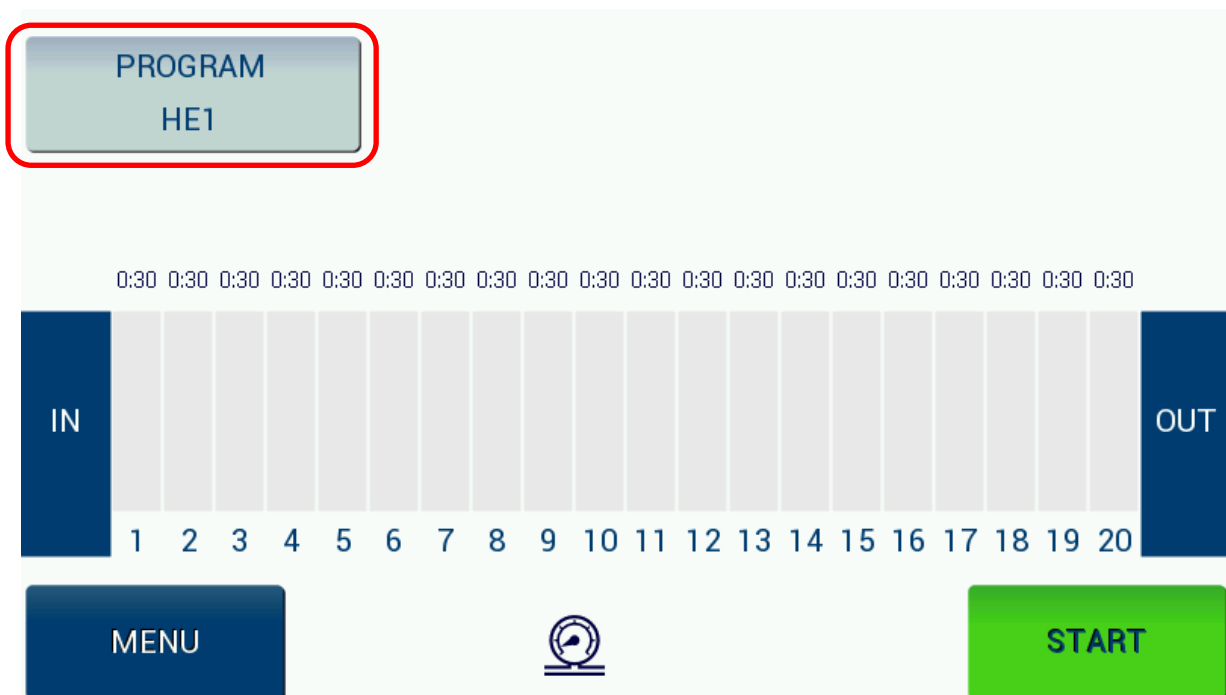

4.7.3 Start the program

You start the program by pressing the “Start” button.

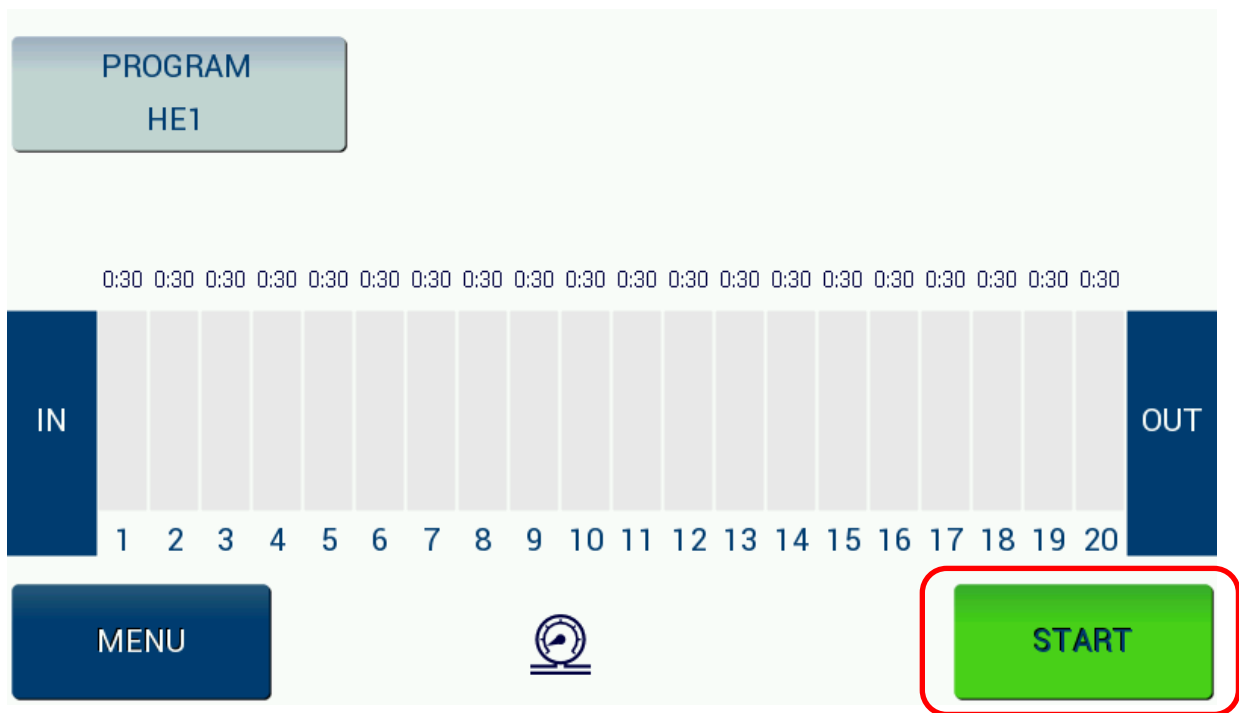

Sample program – in this case PAP staining:



Bath 1 - 3	30 seconds	reagent
Bath 4	15 seconds	water
Bath 5	3 minutes	reagent
Bath 6	1 minute	water
Bath 7	20 seconds	reagent
Bath 8:	30 seconds	reagent
Bath 9:	1 minute	reagent
Bath 10:	1 minute	reagent
Bath 11	30 seconds	reagent
Bath 12	15 seconds	reagent
Bath 13	20 seconds	water
Bath 14	20 seconds	reagent
Bath 15	30 seconds	reagent
Bath 16	40 seconds	reagent
Bath 17	10 seconds	water
Bath 18	15 seconds	reagent
Bath 19	20 seconds	reagent
Bath 20	30 seconds	reagent

Blue Bars show the "consumption" of reagents (ReagentManagementSystem).

Above mentioned example shows a first run. Slide basket is in bath no. 4 since 8 seconds.

Program with hot air station:

manual: PROGRAM STEPS					
No.	Reagent	Duration	RMS	RQ	Show
1	Hot air station	0:00	OFF		
2	Empty cuvette	<auto>	OFF		
3	Empty cuvette	<auto>	OFF		
4	Empty cuvette	<auto>	OFF		
5	Empty cuvette	<auto>	OFF		
6	Empty cuvette	<auto>	OFF		
7	Empty cuvette	<auto>	OFF		

Navigation buttons: Up arrow, Down arrow, Left arrow

Hot air station temperature to cold (blue):

PROGRAM manual

IN | 1 | 2 | 3 | 4 | 5 | 6 | 7 | 8 | 9 | 10 | 11 | 12 | 13 | 14 | 15 | 16 | 17 | 18 | 19 | 20 | OUT

MENU START

Hot air station temperature to warm (red):

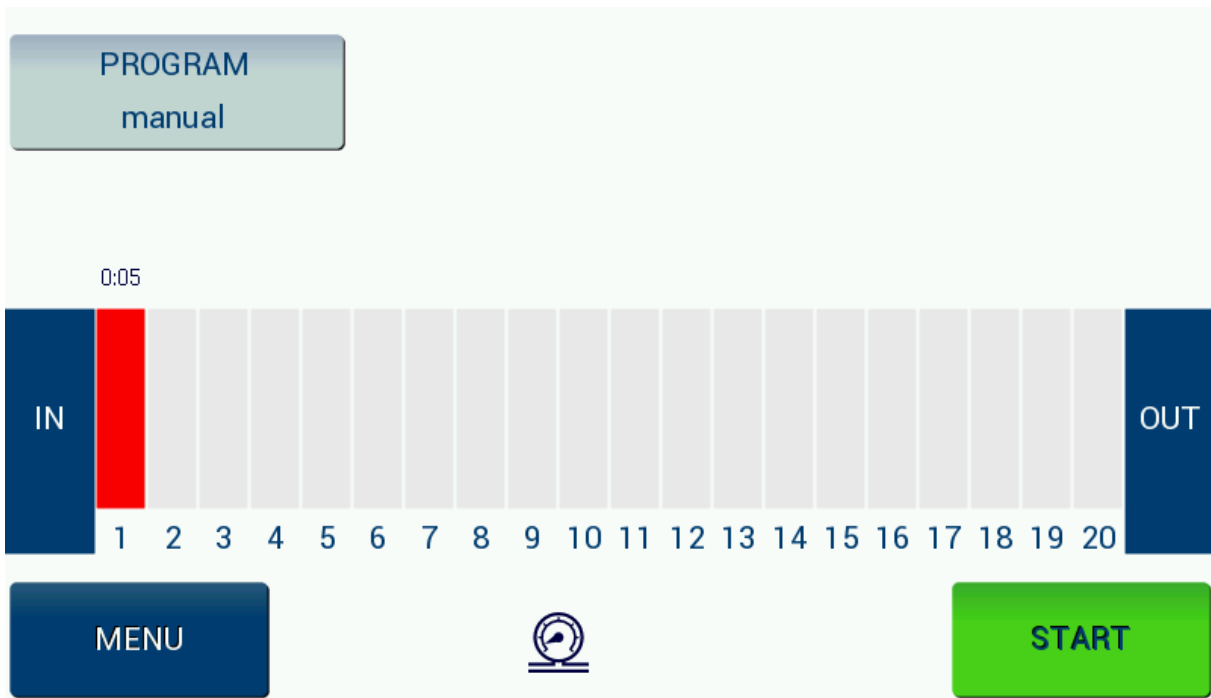

Hot air station error (black):

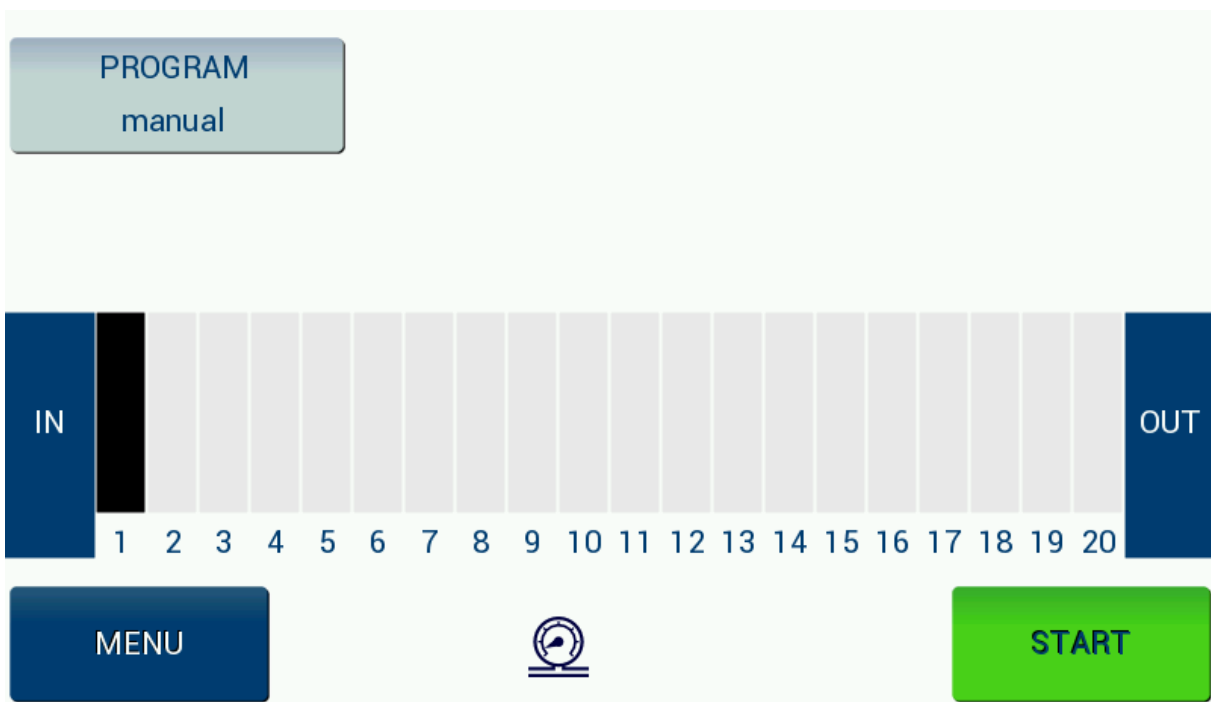

Hot air station set temperature reached (orange):

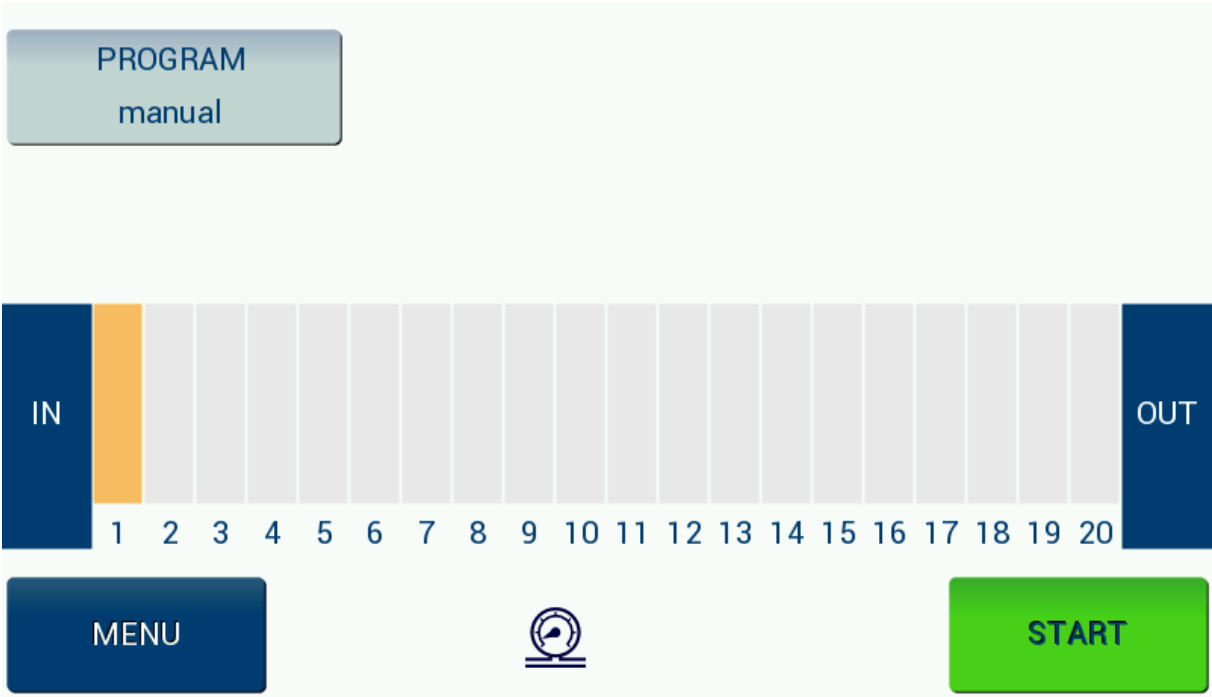

4.7.4 Symbols during program



In mains operation, the battery is showed in grey until it is fully charged. Then the icon disappears.

In floating operation, the battery icon shows the level, dark blue with sufficient residual charge and red below 25%.

When switching off (in the buffer mode) a signal tone sounds. No new samples are recorded in floating operation.

After end of program (or crash) in floating operation, the signal tone sounds also, then then the unit switches itself off.



Monitoring filter runtime, change display.

End of term with icon on the main screen display PopUp with change notice, both at program startup.



Water pressure low

4.7.5 End of program



After the program is finished, slide baskets are placed in the unload station (capacity 5 slide baskets) and the instrument indicates by a ton signal.

In case the unload station is full, the instrument gives the following warning message:

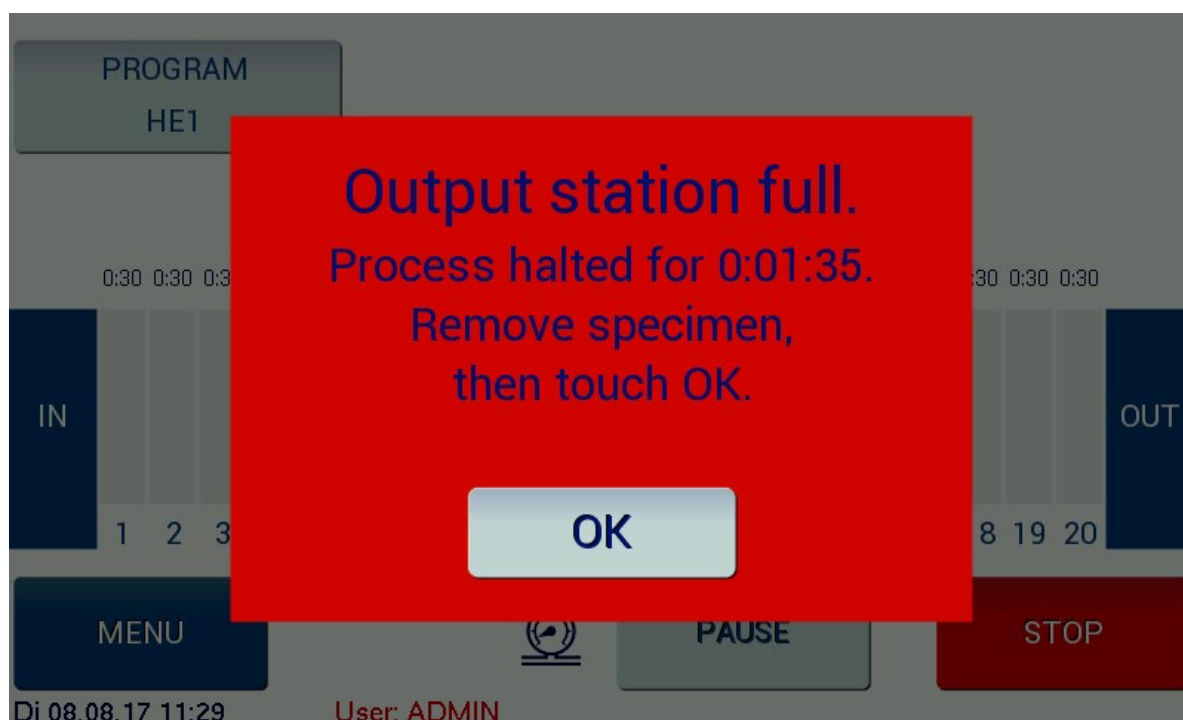

4.7.6 Stop a running program

If you want to stop a running program, press the "Stop" button.

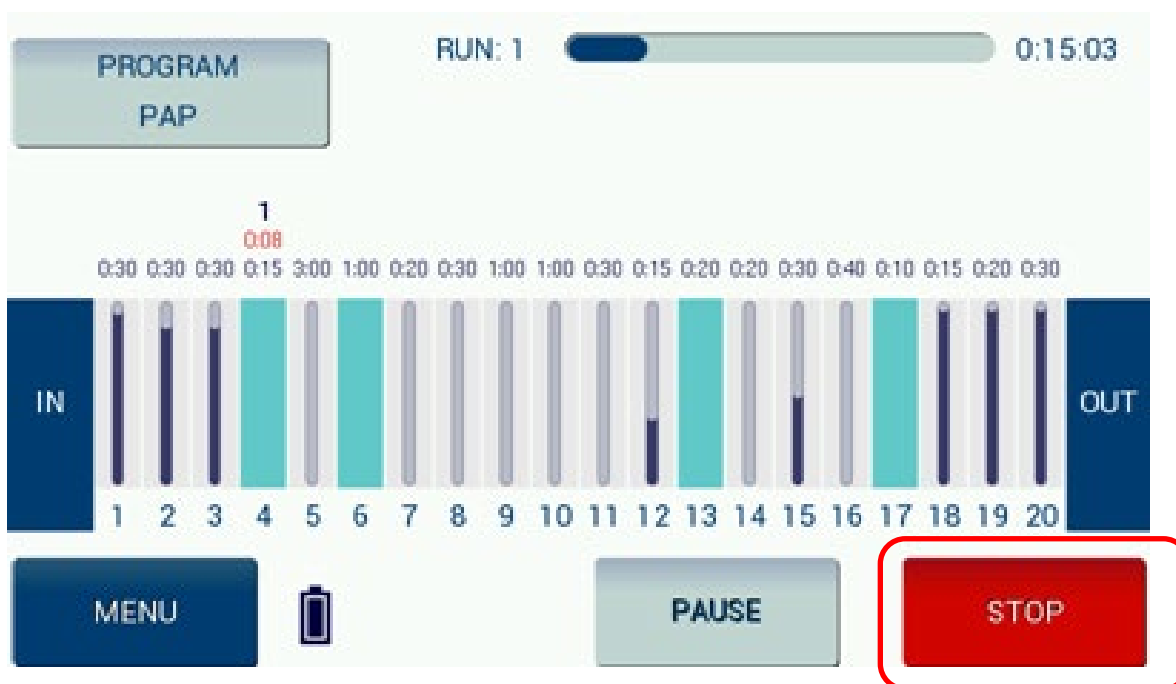

The following message will appear. Press "OK" and the program will stop. You have to take out the slide baskets manually.

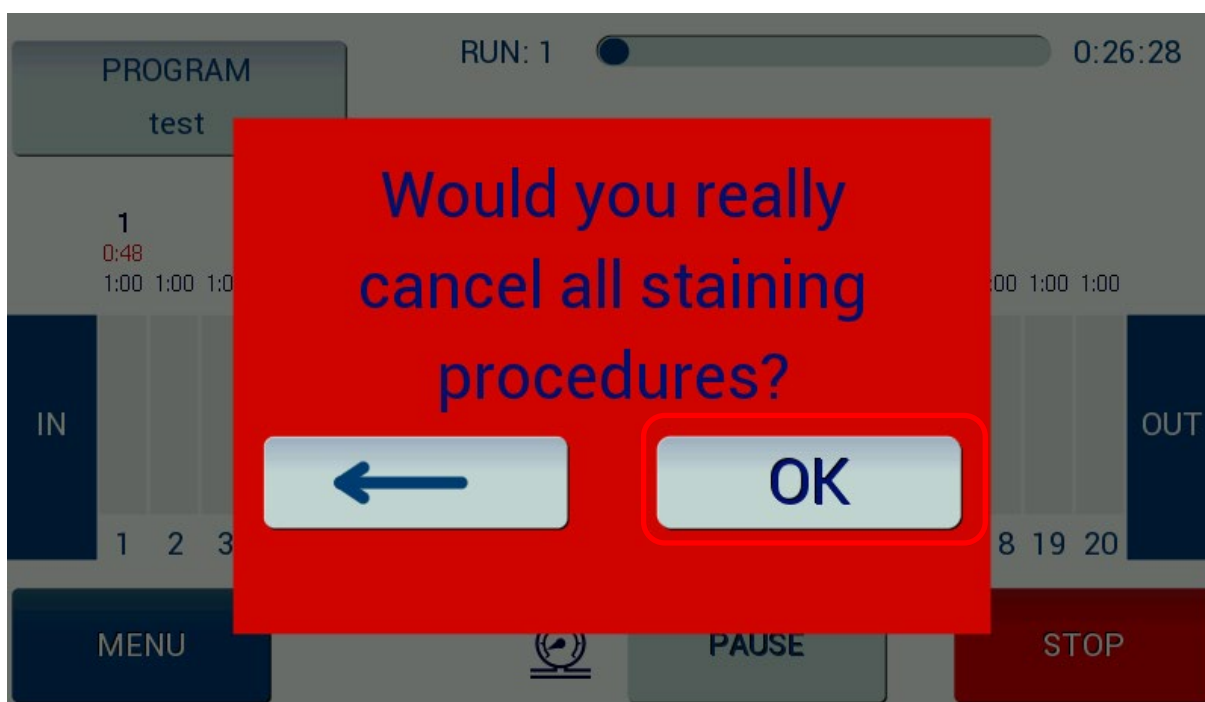

4.7.7 Emergency stop

In case of an emergency, the operation function of the Cromatec can be switched off by pressing the emergency stop located at the lower front of the instrument.

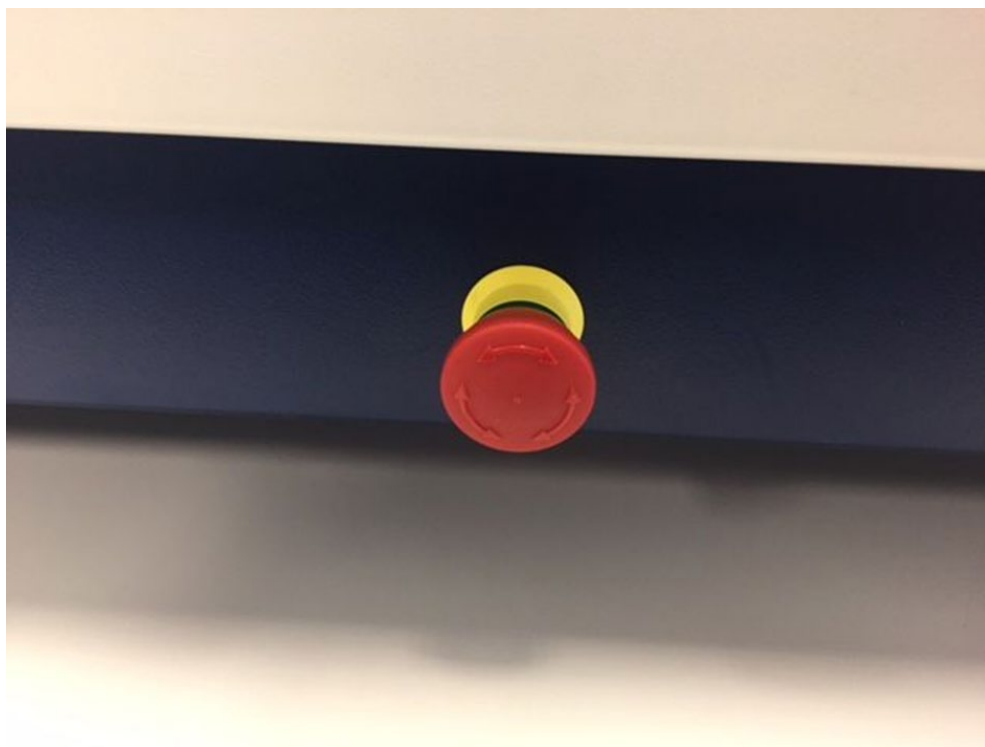

To continue the program, release the emergency stop button and confirm the alarm message.

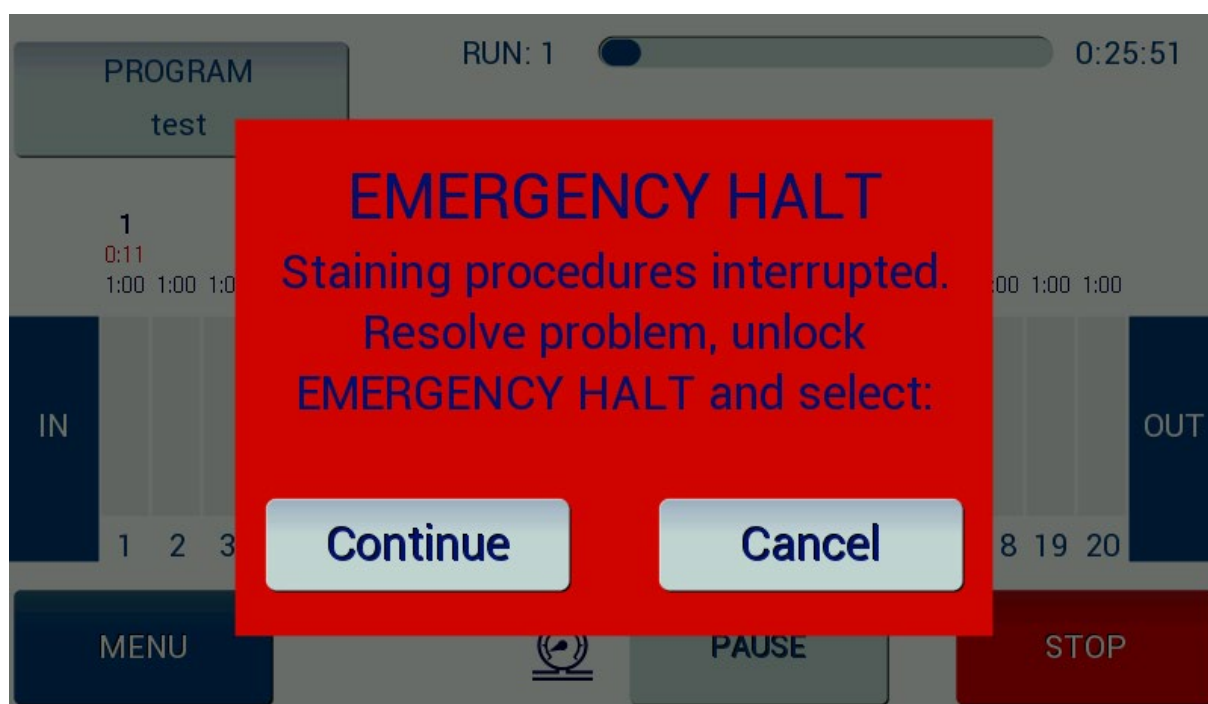





5 Errors

5.1 Notes

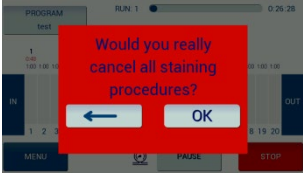
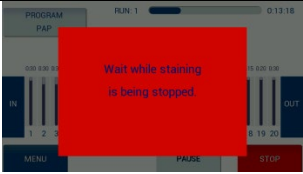
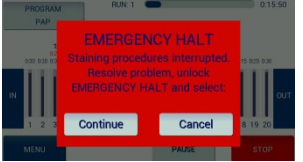
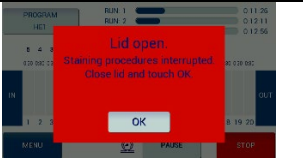
Any failure occurring during the operation of the Cromatec is indicated by an alarm sound and message, shown on the display. Please refer to the trouble shooting list.

5.2 PopUp messages in normal operation

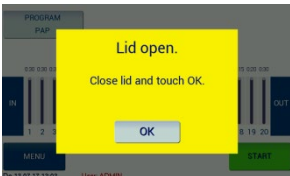
<p>After pressing STOP: Red PopUp "Would you really cancel all staining procedures?"</p>	 <p>Press ok to confirm or go back.</p>
<p>After confirming of cancellation: Red Info PopUp</p>	 <p>Wait while staining is being stopped.</p>
<p>After confirming of PAUSE</p>	<p>Staining procedures interrupted since hh:mm:ss Terminate PAUSE with OK</p>
<p>After pressing Emergency button: Red PopUp „EMERGENCY STOP“</p>	 <p>Staining procedures interrupted. Resolve problem, unlock EMERGENCY HALT and select: [Continue] [Cancel]</p>
<p>After canceling by "Cancel" after emergency stop: Red PopUp "EMERGENCY STOP"</p>	<p>Manually remove specimen, then touch OK. [OK]</p>
<p>After opening of hood: Red PopUp „Lid open“</p>	 <p>Staining procedures interrupted. Close lid and touch OK. [OK]</p>

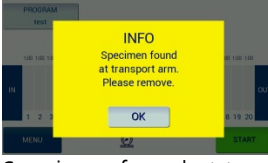
<p>Flow of the filter running time: Yellow PopUp „INFO“</p>	<p>Filter usage time expired, please replace. [OK]</p>
<p>Expiration of reagent: Yellow PopUp „INFO“</p>	 <p>At least one reagent expired, please replace. [OK]</p>
<p>At start attempt despite emergency stop: Yellow PopUp "EMERGENCY HALT"</p>	<p>Resolve problem, unlock EMERGENCY HALT and select: [OK]</p>
<p>When starting with open hood: Yellow PopUp "Lid open"</p>	 <p>Close lid and touch OK. [OK]</p>
<p>When starting with "Auto" inside a program: Yellow PopUp "INFO"</p>	<p>Program invalid: Empty/Auto is allowed only right-aligned. [OK]</p>
<p>At start-up with water requirement and without pressure: Yellow PopUp "INFO"</p>	 <p>Program requires water, but pressure is too low. [OK]</p>
<p>At initial attempt with almost empty battery: Yellow PopUp "INFO"</p>	 <p>Battery voltage too low, charge before starting. [OK]</p>
<p>In the case of a start experiment with samples still attached to the arm: Yellow PopUp (State after prior emergency stop) "INFO"</p>	 <p>Specimen found at transport arm. Please remove. [OK]</p>

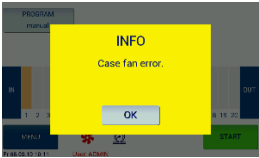
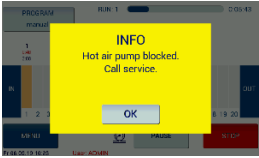
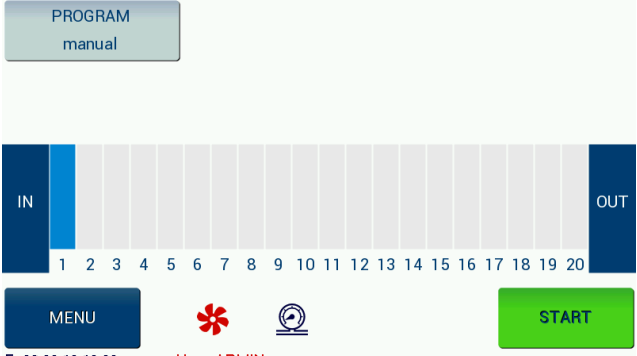
<p>On start with expired filter running time: Yellow PopUp "INFO"</p>	<p>Filter usage time expired please replace. [OK] (Start nevertheless possible)</p>
<p>When starting with reagents that have expired: Yellow PopUp "INFO"</p>	<p>At least one reagent expired, please replace. [OK] (Start nevertheless possible)</p>
<p>When fan error occurs while hot air station is in use, hot air station will be switched off for safety reasons. Call service.</p>	
<p>Hot air station is not working anymore. Call service.</p>	
<p>In addition to the yellow pop up, the red fan icon will show up. Call service.</p>	

5.3 Error messages in normal operation – only Cromatec II

<p>Motor Error: Red PopUp "MOTOR ERROR"</p>	<p>Staining procedures interrupted since hh:mm:ss [Retry] [Cancel]</p> <p>Messages: Overcurrent horizontal Overcurrent vertical Timeout horizontal Timeout vertical</p>
<p>Failure of the magnetic control: Red PopUp "MAGNET ERROR"</p>	<p>Specimen transport impossible Manually remove specimen and call service</p> <p>Note: no OK-Button, present program will be cancelled!</p>
<p>Downstream pressure: Red PopUp "ERROR"</p>	<p>Water pressure too low. [OK]</p>
<p>Leakage: Red PopUp "ERROR"</p>	<p>Water leakage detected. -- places see below. -- [OK] Places: (container) (enclosure) (container and enclosure)</p>
<p>No more samples in the enema during the admission test: Yellow PopUp "INFO"</p>	<p>No specimen found in input station. [OK]</p>
<p>Other holders in the system when attempting to take sample holders: Yellow PopUp "INFO"</p>	<p>Specimen found in stations 1-20. Please remove. [OK]</p>
<p>Output station full: Red PopUp "Output station full"</p>	<p>Process hold for hh:mm:ss. Remove specimen, then touch OK. [OK]</p>
<p>Glue the sample holder to the arm (raised too much): Red PopUp „ERROR"</p>	<p>Specimen sticking at n1 n2 n3 (Station number) Correct, then touch OK. [OK]</p>

Specimen lost (while lifting down): Red PopUp „ERROR“	Specimen lost at n1 n2 n3 (station no.) Correct, then touch OK. [OK]
Specimen holder stick or lost (combination 8+9): Red PopUp „ERROR“	Specimen sticking at n1 n2 n3 (station no.) Specimen lost at n4 n5 n6 (station no.) Correct, then touch OK. [OK]
Unexpected samples in the unit (detected during lowering): Red PopUp „ERROR“	Alien specimen found at n1 n2 n3 (station no.) Correct, then touch OK. [OK]
Fail-safe sensor in run-in station (continuous signal): Red PopUp „ERROR“	Input station sensor failure. [OK]
Invalid internal state: Red PopUp „SYSTEM ERROR“	Invalid internal state. Touch OK and shutdown. [OK]
Display not working or not connected correctly	Lights are flashing



Never use deformed baskets. A damaged basket can stop the staining process.

Fill the baths up to the mark. Check the filling level daily.

5.4 Power failure – only Cromatec II

The Cromatec has a built-in battery to allow the unit to work even in a case of power failure. In case of a power failure the display shows the following symbol:

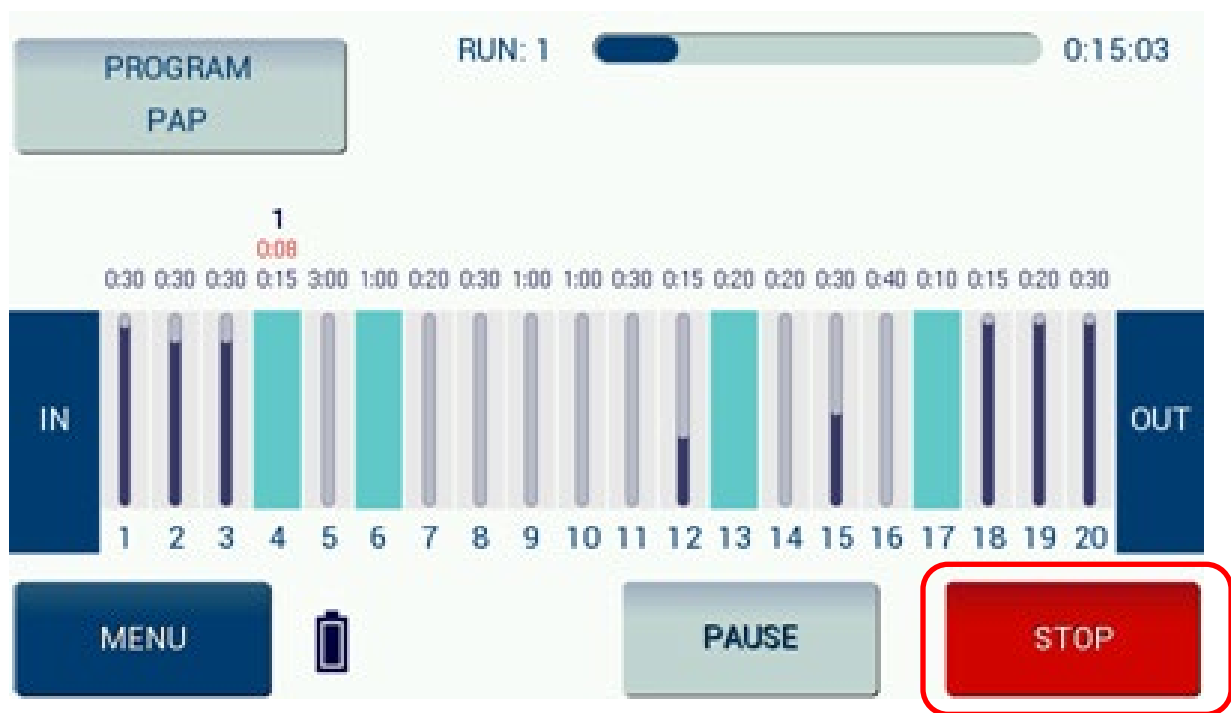

The operation is continued using the emergency power supply. As the battery gets loaded during operation, a fully loaded device can be operated using the battery. However, new slide baskets shall not be placed during indicated battery operation.

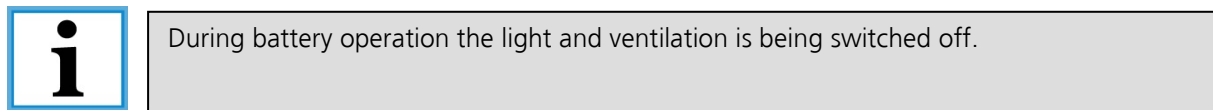

During battery operation the light and ventilation is being switched off.

If the power comes back, the battery symbol disappears and the device turns back to regular operation, including light and ventilation. No action from the user is needed.

5.5 Hood

When the hood is opened, the instrument stops immediately and the following Red PopUp window is shown.



The cromatec II will not perform any staining program while the lid is open. When the lid is opened, the ventilation will automatically be increased.

6 Cleaning

6.1 General cleaning advice

The Slee linear stainer Cromatec I / II has a solvent resistant surface area according to the requirements of histological laboratories so that an easy cleaning can be done without problems. Only the display should be cleaned with a damp cloth.



Before starting the cleaning, please turn off the instrument. Dispose of used reagents according to the laboratory regulations in force in your country.

Do not use alcohol, detergents containing alcohol (window cleaner!), abrasive cleaning powders, solvents containing acetone or xylene.

Inner side of the Cromatec I / II:

Please remove the cuvettes and clean the stainless-steel inner panels carefully with a regular cleaner.

Transport system:

Be careful with the lower side, where the magnets are located. In normal operation it should be sufficient to wipe with a water moisture cloth.

Outside surfaces:

Please clean the outside surfaces with a mild detergent and subsequently wipe down with a moistened cloth.

For the window, use a moisture cloth.

Screen:

Please use a commercial screen cleaner for cleaning the touch screen.

Cuvettes:

It is also possible to clean the staining cuvettes with a usual dish washer. Please consider the chemical rests in the troughs and their harmful influences to the environment.

Inlet/Outlet hose:

Please check weekly the waste water drain hose for accumulated dirt, particularly for algae. Clean whenever necessary.

6.2 Disposal

The instrument or parts of the instrument must be disposed of according to existing local applicable regulations.



Do not expose the instrument to regular domestic or industry waste. It contains electrical parts that can be dangerous to the environment!

Optimized H&E program

Station	Reagent	Time
1	Xylol	1,30
2	Isopropanol	1,30
3	Isopropanol	1,30
4	96% Ethanol	1,30
5	96% Ethanol	1,30
6	Water	1,30
7	Hemalum	1,30
8	Hemalum	1,30
9	Water	1,30
10	Glacial acetic acid	1,30
11	Running Water	1,30
12	Running Water	1,30
13	96% Ethanol	1,30
14	96% Ethanol	1,30
15	Eosin	1,30
16	96% Ethanol	1,30
17	96% Ethanol	1,30
18	Isopropanol	1,30
19	Isopropanol	1,30
20	Xylol	1,30

Notes



SLEE medical GmbH · Am Neuberg 14
55268 Nieder-Olm · Germany
www.slee.de

T: +49 (0) 6136 76997-0
E: mail@slee.de



www.slee.de



[YouTube](#)



[LinkedIn](#)



[Instagram](#)

