



O P E R A T I N G
M A N U A L

slee solutions
for
pathology

TISSUE PROCESSOR
MTP

COST-EFFECTIVE PREMIUM TISSUE PROCESSING
HIGHEST RELIABILITY
EASY CLEANING

DESIGN &
MANUFACTURING
MADE IN GERMANY

CONTENTS



1	INTENDED USE	5
2	SYMBOLS	5
3	SAFETY NOTES	5
4	COMPONENTS	6
5	SPECIFICATIONS	7
6	UNPACKING AND INSTALLATION	8
6.1	UNPACKING THE DEVICE	8
6.2	INSTALLATION	9
6.3	INSTALLATION OF HOOD	9
7	INITIAL OPERATION	10
7.1	CONTROL PANEL	10
7.2	STARTUP	11
7.3	STANDARD SETTINGS	11
7.4	PREPARATION AND LOADING	16
8	OPERATION	20
8.1	MANUAL MODE	20
8.2	QUICKSTART	22
8.3	SETTING AND STORAGE OF CUSTOMIZED PROGRAMS	25
8.4	RUNNING A PROGRAM	29
8.5	TIME DELAY	31
8.6	DISCONTINUATION OF A RUN	33
8.7	SHUT DOWN	34
8.8	TWIN BASKET OPTION	34
8.9	HOOD	35
8.10	FAN / CARBON FILTER	36
8.11	PARAFFIN VACCUUM FUNCTION	36
9	MAINTENANCE	37
9.1	RECOMMENDED MAINTENANCE AND SERVICE SCHEDULE	37

10	SERVICE	38
11	Optional accessories	39
12	WARRANTY	40
13	DISPOSAL	40

1 INTENDED USE

The automatic tissue processor MTP is intended for automatic fixation, dehydration and infiltration of histological tissue samples with fixatives, alcohol, solvents and paraffin wax for professional use in routine and research laboratories in the fields of biology, medicine and industry.

2 SYMBOLS

	Dangers, warnings and cautions are marked by this symbol.
	Special instructions regarding the operation of the device are marked by this symbol.
	Hot surfaces are marked by this symbol. Avoid direct contact to prevent risk of burning.

3 SAFETY NOTES

The Slee carousel tissue processor MTP is provided with the following safety features:

		Standard	Optional Accessory
Device Safety	Slide coupling	•	
Process Safety	Backup battery	•	
	Password protection	•	
	Status monitor	•	
	Remote alarm system		•
User Safety	Hood		•
	Carbon filter		•
	Electrical fan		•

The institution which owns the unit and the persons working with the unit, servicing or repairing it have the responsibility for a hazard-free use.

ELECTRICAL POWER CONNECTION

Do not use any extension lead.



Before installing the device, check that the electrical connection values match the information on the name plate and that a consistent power supply is guaranteed.

- This should be examined during installation of the unit by a competent person.
- Use a dedicated fuse for the unit.
- Do not connect another unit to the same power circuit.
- Before turning on the device, check if the voltage of the mains supply is identical with the name plate of the unit.
- The mains supply should not be connected in series with other devices, such as multiple sockets - a separate circuit should be provided.

4 COMPONENTS

The Slee carousel tissue processor MTP is provided with the following standard components:

	MTP
Basic unit	•
10 x Reagent beakers (POM, white)	•
2 x Heated aluminum paraffin beakers	•
1 x Stainless steel transport basket Capacity of 120 standard cassettes	•
1 x Labelling set for reagent beakers	•
Operation manual	•
Mains cable	•

5 SPECIFICATIONS

General

Nominal supply voltage / frequency	100 – 240 V AC (+ / -10 %) / 50 – 60 Hz
Power draw	250 VA
Protective class	(1) I
Power fuses	2 x T 6.3 A
Pollution degree	(1) 2
Overvoltage installation category	II
Maximum heat emission	250 J / s
Operating temperature range	+10 to +35 °C
Operating humidity	max. rel. 80 % non-condensing
Storage temperature range	+5 to +55 °C
Storage humidity	max. rel. 80 % non-condensing
Dimensions (W x D x H)	850 mm x 850 mm x 750 mm
Weight (w/o accessories)	80 kg
Reagent beakers	Standard: 2,000 ml, white, polyacetal (Optional): 2,000 ml, DURAN® glass (Optional): 2,000 ml, aluminum
Paraffin beakers	2,000 ml, aluminum, double walled
Transport basket	Standard: 1 x Stainless steel, capacity 120 cassettes Optional: 2 x stainless steel, capacity 120 cassettes each
Programming	20 programs (freely programmable), password protected
Incubation time (Exposure)	1 sec up to 99 h 59 min 59 sec (freely programmable)
Drip of time	30 sec up to 59 min 59 sec (freely programmable)
Paraffin beaker temp.	Temperature range 40 °C to 80 °C (freely programmable)
Device operation modes	Immediate start Fixed start time: Delay programmable up to 999 hours Fixed end time: Process end time delayed up to 99 hours Quick start (factory programmed protocols)
Agitation	Yes (factory setting for intensity)
Power failure failsafe position	Freely programmable for any protocol step
Control elements	LCD display System Status Monitor
Vacuum function (optional)	Pressure difference 0.5 bar maximum (500 h Pa)
Exhaust air volume	Minimum air volume approx. 200 m ³ / h Required pressure difference of approx. 100 Pascal (Pa) Nominal diameter for hose connection on the back is 100 mm.

(1) According to IEC 1010, EN 61010

6 UNPACKING AND INSTALLATION

6.1 UNPACKING THE DEVICE

Remove the upper wooden cover. Remove the upper supporting foams.

Lift the device out of the wooden transportation case. Remove the transport locks.

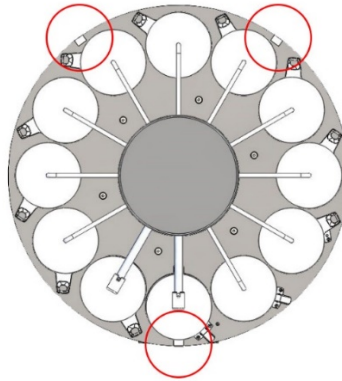

Lift the device according to the photo only at the platform for the reagent beakers or at the bottom of the device, never at the black turn-table or the arms.

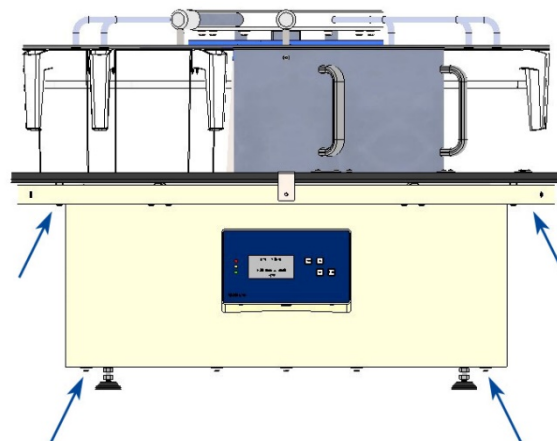

Keep the packaging material and the transport lock for later transport purposes, as the tissue processor should be transported in its original packaging to avoid transport damage.



Please, before the installation of the device at the final location remove the 3 transport locks, otherwise there is a risk of damage to the device.

Place the device onto the selected bench.

6.2 INSTALLATION

The place of use for the MTP should meet the following conditions to ensure the specified equipment performance:

- The unit should be positioned onto a plane level and vibration-free surface.
- Leave a minimum distance of 10 – 20 cm between the right side and left side of the device and the back of the device to the walls or furnishings.

6.3 INSTALLATION OF HOOD

In case of the option Perspex hood (Item No. 11000220), it must be installed as follows:

- a) Please first mount the 5 spacers into the thread of the housing.

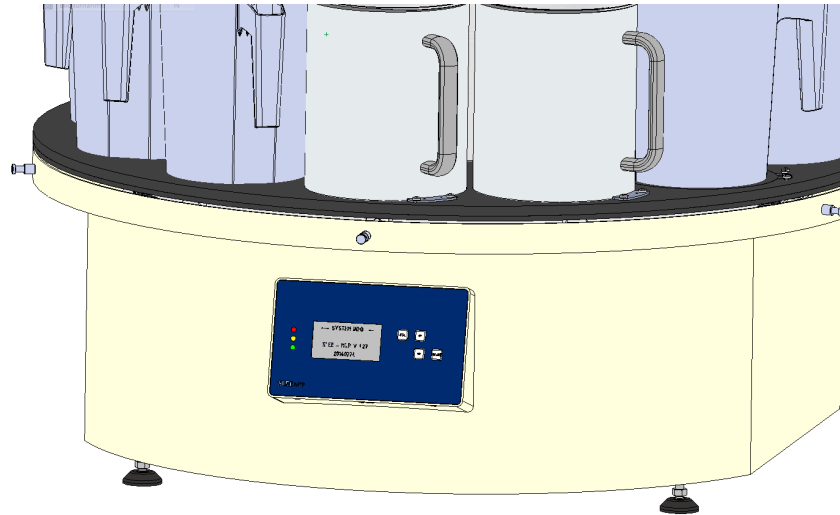

- b) Place the hood onto the housing. The spacers will fix the hood against rotation, and at the same time prevent the protective hood from twisting.

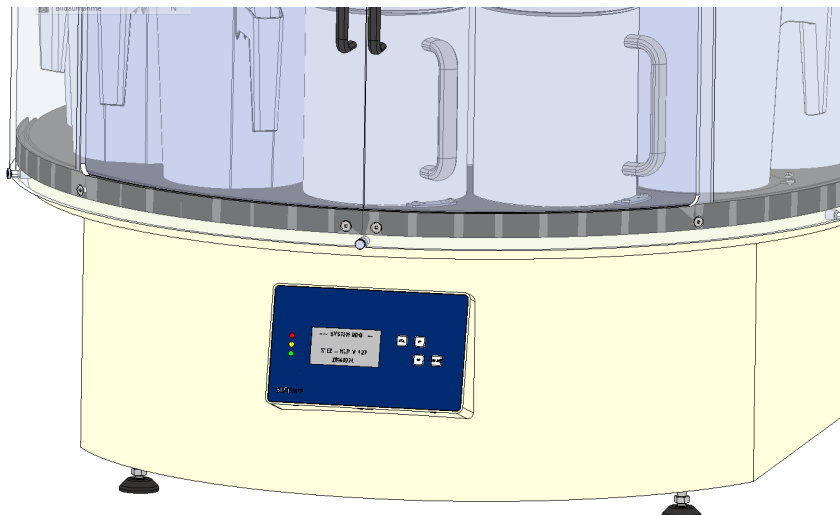







7 INITIAL OPERATION



7.1 CONTROL PANEL









The control panel is furthermore equipped with a status monitor that provides immediate information about the status of the system. There are 3 different status modes that can be displayed:



	<p>GREEN</p> <p>The system is ready for a new process or an already running process is running without interference.</p>
	<p>YELLOW</p> <p>The system is on hold and requires further user entry to continue a process or the power supply is cut and the system is running on battery.</p>
	<p>RED</p> <p>The system is on error and requires service action.</p>



<p>Select Date by pressing  or .</p> <p>Press  to change the system date.</p>	----- SETUP -----									
	<table> <tr><td>Time</td><td>15:30:10</td></tr> <tr><td>Date</td><td>22.01.21</td></tr> <tr><td>Fan</td><td>ON</td></tr> <tr><td>Vacuum</td><td>----</td></tr> <tr><td>Vacuum all</td><td>----</td></tr> </table>	Time	15:30:10	Date	22.01.21	Fan	ON	Vacuum	----	Vacuum all
Time	15:30:10									
Date	22.01.21									
Fan	ON									
Vacuum	----									
Vacuum all	----									



<p>Select Fan by pressing  or .</p> <p>Press  to change the operation of the fan.</p> <p>[only applicable to devices equipped with ventilation fan]</p>	----- SETUP -----									
	<table> <tr><td>Time</td><td>15:30:10</td></tr> <tr><td>Date</td><td>22.01.21</td></tr> <tr><td>Fan</td><td>ON</td></tr> <tr><td>Vacuum</td><td>----</td></tr> <tr><td>Vacuum all</td><td>----</td></tr> </table>	Time	15:30:10	Date	22.01.21	Fan	ON	Vacuum	----	Vacuum all
Time	15:30:10									
Date	22.01.21									
Fan	ON									
Vacuum	----									
Vacuum all	----									



<p>Select Vacuum by pressing  or .</p> <p>Press  to change the operation of the vacuum system.</p> <p>[not applicable to MSM devices]</p>	----- SETUP -----									
	<table> <tr><td>Time</td><td>15:30:10</td></tr> <tr><td>Date</td><td>22.01.21</td></tr> <tr><td>Fan</td><td>ON</td></tr> <tr><td>Vacuum</td><td>----</td></tr> <tr><td>Vacuum all</td><td>----</td></tr> </table>	Time	15:30:10	Date	22.01.21	Fan	ON	Vacuum	----	Vacuum all
Time	15:30:10									
Date	22.01.21									
Fan	ON									
Vacuum	----									
Vacuum all	----									







<p>Select Vacuum all by pressing  or .</p> <p>Press  to change the operation of the vacuum system for all positions.</p> <p>[not applicable to MTP devices without vacuum all function and MSM devices]</p>	----- SETUP -----									
	<table> <tr><td>Time</td><td>15:30:10</td></tr> <tr><td>Date</td><td>22.01.21</td></tr> <tr><td>Fan</td><td>ON</td></tr> <tr><td>Vacuum</td><td>----</td></tr> <tr><td>Vacuum all</td><td>----</td></tr> </table>	Time	15:30:10	Date	22.01.21	Fan	ON	Vacuum	----	Vacuum all
Time	15:30:10									
Date	22.01.21									
Fan	ON									
Vacuum	----									
Vacuum all	----									



<p>Select Heater by pressing  or .</p> <p>Press  to change the operation of the heating unit. [only applicable to devices equipped with a heating unit (MSM)]</p>	----- SETUP -----									
	<table> <tr><td>Heater</td><td>----</td></tr> <tr><td>Delay</td><td>Start</td></tr> <tr><td>Def. End</td><td>Mon 08:00</td></tr> <tr><td>Language</td><td>English</td></tr> <tr><td>Contrast</td><td>14</td></tr> </table>	Heater	----	Delay	Start	Def. End	Mon 08:00	Language	English	Contrast
Heater	----									
Delay	Start									
Def. End	Mon 08:00									
Language	English									
Contrast	14									



<p>Select Delay by pressing  or .</p> <p>Press  to change the delay function either to delay of the process starting time or the delay program end.</p>	----- SETUP -----									
	<table> <tr><td>Heater</td><td>----</td></tr> <tr><td>Delay</td><td>Start</td></tr> <tr><td>Def. End</td><td>Mon 08:00</td></tr> <tr><td>Language</td><td>English</td></tr> <tr><td>Contrast</td><td>14</td></tr> </table>	Heater	----	Delay	Start	Def. End	Mon 08:00	Language	English	Contrast
Heater	----									
Delay	Start									
Def. End	Mon 08:00									
Language	English									
Contrast	14									



<p>Select Def. End by pressing  or .</p> <p>Press  to change the default time for the program end.</p>	----- SETUP -----									
	<table> <tr><td>Delay</td><td>Start</td></tr> <tr><td>Def. End</td><td>Mon 08:00</td></tr> <tr><td>Language</td><td>English</td></tr> <tr><td>Contrast</td><td>14</td></tr> <tr><td>Fan speed (open)</td><td>7</td></tr> </table>	Delay	Start	Def. End	Mon 08:00	Language	English	Contrast	14	Fan speed (open)
Delay	Start									
Def. End	Mon 08:00									
Language	English									
Contrast	14									
Fan speed (open)	7									



<p>Select Language by pressing  or .</p> <p>Press  to change the system language.</p>	----- SETUP -----									
	<table> <tr><td>Delay</td><td>Start</td></tr> <tr><td>Def. End</td><td>Mon 08:00</td></tr> <tr><td>Language</td><td>English</td></tr> <tr><td>Contrast</td><td>14</td></tr> <tr><td>Fan speed (open)</td><td>7</td></tr> </table>	Delay	Start	Def. End	Mon 08:00	Language	English	Contrast	14	Fan speed (open)
Delay	Start									
Def. End	Mon 08:00									
Language	English									
Contrast	14									
Fan speed (open)	7									

<p>Select Contrast by pressing  or .</p> <p>Press  to change the contrast of the display.</p> <p>[The contrast of the display can also be changed in the main menu by pressing  and  or .</p>	<p style="text-align: center;">----- SETUP -----</p> <table border="0"> <tr> <td>Delay</td> <td>Start</td> </tr> <tr> <td>Def. End</td> <td>Mon 08:00</td> </tr> <tr> <td>Language</td> <td>English</td> </tr> <tr> <td>Contrast</td> <td>14</td> </tr> <tr> <td>Fan speed (open)</td> <td>7</td> </tr> </table>	Delay	Start	Def. End	Mon 08:00	Language	English	Contrast	14	Fan speed (open)	7
Delay	Start										
Def. End	Mon 08:00										
Language	English										
Contrast	14										
Fan speed (open)	7										



<p>Select Fan speed (open) by pressing  or .</p> <p>Press  to change the fan speed when the transport basket is lifted.</p>	<p style="text-align: center;">----- SETUP -----</p> <table border="0"> <tr> <td>Delay</td> <td>Start</td> </tr> <tr> <td>Def. End</td> <td>Mon 08:00</td> </tr> <tr> <td>Language</td> <td>English</td> </tr> <tr> <td>Contrast</td> <td>14</td> </tr> <tr> <td>Fan speed (open)</td> <td>7</td> </tr> </table>	Delay	Start	Def. End	Mon 08:00	Language	English	Contrast	14	Fan speed (open)	7
Delay	Start										
Def. End	Mon 08:00										
Language	English										
Contrast	14										
Fan speed (open)	7										

<p>Select Fan speed (closed) by pressing  or .</p> <p>Press  to change the fan speed when the transport basket is lowered into the reagent beakers during incubation.</p>	<p style="text-align: center;">----- SETUP -----</p> <table border="0"> <tr> <td>Fan speed (open)</td> <td>7</td> </tr> <tr> <td>Fan speed (closed)</td> <td>2</td> </tr> <tr> <td>Temperatures</td> <td></td> </tr> <tr> <td>Display System info</td> <td></td> </tr> <tr> <td>User PIN</td> <td>off</td> </tr> </table>	Fan speed (open)	7	Fan speed (closed)	2	Temperatures		Display System info		User PIN	off
Fan speed (open)	7										
Fan speed (closed)	2										
Temperatures											
Display System info											
User PIN	off										

<p>Select Temperatures by pressing  or .</p> <p>Press  to display the temperature of the paraffin beakers.</p>	<p style="text-align: center;">----- SETUP -----</p> <table border="0"> <tr> <td>Fan speed (open)</td> <td>7</td> </tr> <tr> <td>Fan speed (closed)</td> <td>2</td> </tr> <tr> <td>Temperatures</td> <td></td> </tr> <tr> <td>Display System info</td> <td></td> </tr> <tr> <td>User PIN</td> <td>off</td> </tr> </table>	Fan speed (open)	7	Fan speed (closed)	2	Temperatures		Display System info		User PIN	off
Fan speed (open)	7										
Fan speed (closed)	2										
Temperatures											
Display System info											
User PIN	off										

<p>Select Display System info by pressing  or .</p> <p>Press  to display system info.</p>	<p style="text-align: center;">----- SETUP -----</p> <p>Fan speed (open) 7</p> <p>Fan speed (closed) 2</p> <p>Temperatures</p> <p>Display System info</p> <p>User PIN off</p>
--	--

<p>Select User PIN by pressing  or .</p> <p>Press  to activate a User PIN.</p>	<p style="text-align: center;">----- SETUP -----</p> <p>Fan speed (open) 7</p> <p>Fan speed (closed) 2</p> <p>Temperatures</p> <p>Display System info</p> <p>User PIN off</p>
---	--





<p>Select System Configuration by pressing  or .</p> <p>Press  to enter system configuration menu.</p> <p>[only applicable to service technicians]</p>	<p style="text-align: center;">----- SETUP -----</p> <p>Fan speed (closed) 2</p> <p>Temperatures</p> <p>Display System info</p> <p>User PIN off</p> <p>System Configuration</p>
---	--

7.4 PREPARATION AND LOADING

Preparation of reagent solutions

Position reagent beakers and paraffin wax beakers outside the device onto a plane and clean working bench.

Fill the reagent beakers with the intended reagents up to the filling mark on the inside. Fill the paraffin wax beakers with molten paraffin or paraffin wax pellets.

	<p>The heated wax baths are restricted to the use with paraffin.</p> <p>Under no circumstances may they be filled with solvents such as alcohol or xylene. When solvents heat, a highly explosive mixture builds up! Caution!</p>
	<p>The heated paraffin beakers become very hot when the heating function is activated! Do not touch the beaker except on the handle. Risk of injury!</p> <p>Caution when handling hot paraffin! Risk of injury!!</p>
	<p>Placement of filled reagent beakers and paraffin wax beakers can be performed by motor-turning the respective carousel position to the front end of the device (See MANUAL MODE).</p>
	<p>The following media may be used in the MTP (equipped with POM beakers):</p> <ul style="list-style-type: none">• Water• Formalin• Ethanol• Methanol• Xylene• Paraffin• Chlorothene <p>Xylene substitutes must be checked because the chemical compounds are currently not available.</p>
	<p>Please do not use chloroform, acetone and toluene (Methylbenzene).</p>

Loading of filled reagent beakers and heated paraffin beakers

Load filled reagent beakers into their respective positions (1 to 10) onto the carousel, resp. 9 using a second transport basket. For easy access, move the turning table with the target position to the front side of the device (see also 8.1 MANUAL MODE).

Load filled paraffin wax beakers into position 11 and 12 (resp. 10 to 12 using a second transport basket) onto the carousel. Ensure that the electrical plug is locked in place to allow perfect heating function of the beaker.

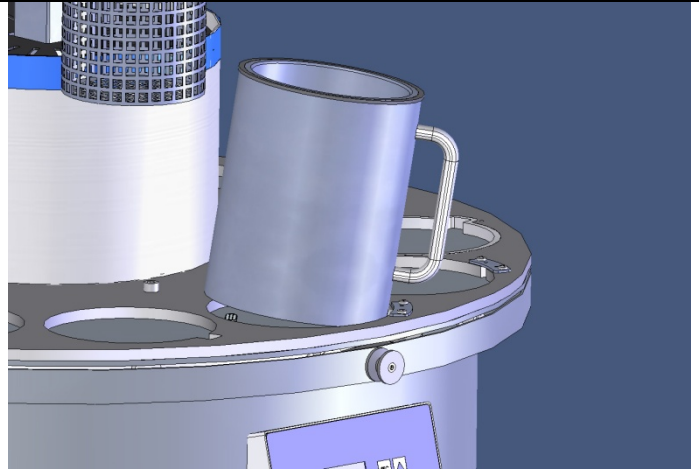

Loading of heated paraffin beaker into position 11 or 12 (optionally also 10).

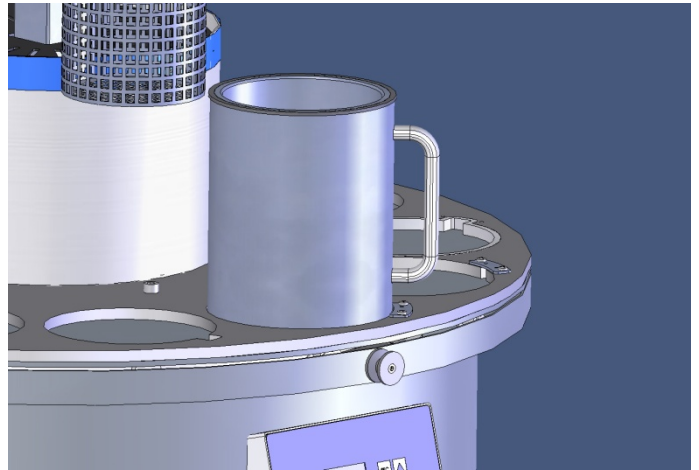

Locking of electrical plug-in connection of paraffin beaker.

Loading of transport basket

To load the transport basket with tissue cassettes, unlock the lid by turning the lid counter clockwise and then lifting the lid from the basket.

To close the transport basket, push the lid into the guidance and turn the lid clockwise to lock the lid.

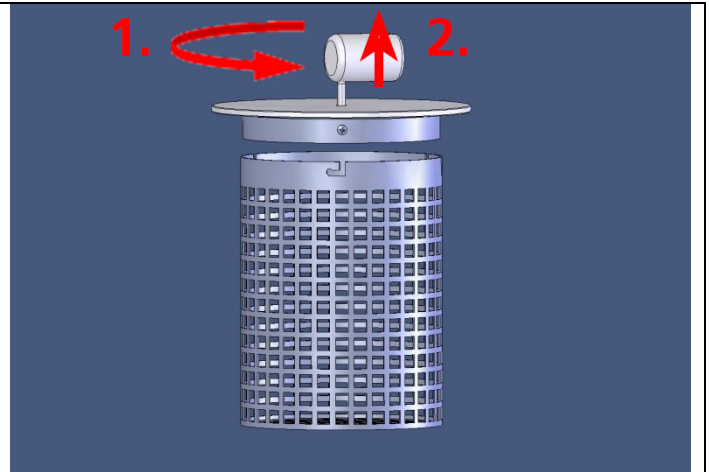

Loading of heated paraffin beaker into position 11 or 12 (optionally also 10).

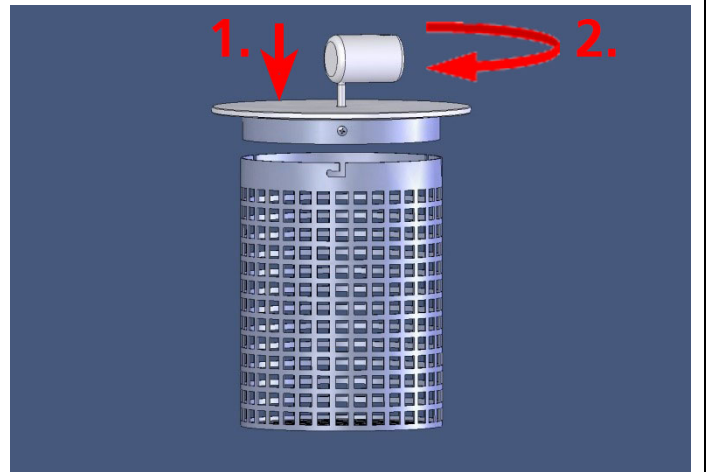

Locking of electrical plug of paraffin beaker.

The transport basket can then be loaded to the device. Therefore, press the transport basket into the designated holder until the closure is snapped into place.

Check the correct positioning before starting a run.

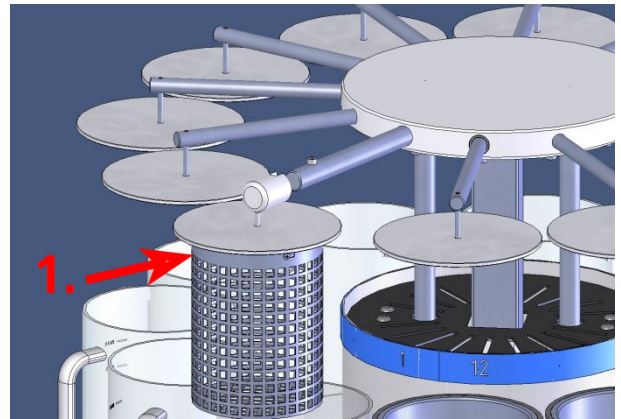

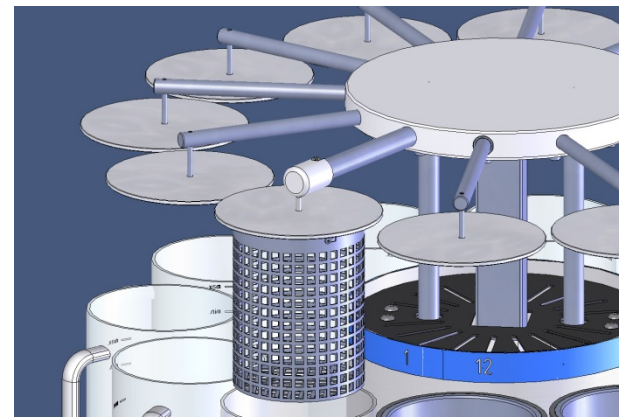

Hanging loaded transport basket into the holder of the lifting unit.









Correct positioning of transport basket in holder of the lifting unit.







8 OPERATION



8.1 MANUAL MODE



<p>Select Manual operation by pressing  or .</p> <p>Press  to enter the manual operation menu.</p>	<p style="text-align: center;">---- MAIN MENU ----</p> <p>QUICKSTART PROGRAMS MANUAL SETUP 22.01.21 15:30:10</p>
---	--

<p>Select Next station by pressing  or .</p> <p>Press  to start the command. The carousel will move one position forward.</p>	<p style="text-align: center;">---- MANUAL ----</p> <p>Next station (02) Previous station (12) Turn to station no. Move up Move down</p>
--	---

<p>Select Previous station by pressing  or .</p> <p>Press  to start the command. The lifting unit will move one position back.</p>	<p style="text-align: center;">---- MANUAL ----</p> <p>Next station (02) Previous station (12) Turn to station no. Move up Move down</p>
---	---

<p>Select Turn to station no. by pressing  or .</p> <p>Press  to select and select station no. by pressing  or .</p> <p>Press  to start the command. The carousel will move to the selected position.</p>	<p style="text-align: center;">---- MANUAL ----</p> <p>Next station (02) Previous station (12) Turn to station no. Move up Move down</p>
---	---

<p>Select Move up by pressing  or .</p> <p>Press  to start the command. The lifting unit will move up.</p>	<p>---- MANUAL ----</p> <p>Next station</p> <p>Previous station</p> <p>Turn to station no.</p> <p>Move up</p> <p>Move down</p>
---	---

<p>Select Move down by pressing  or .</p> <p>Press  to start the command. The lifting unit will move down.</p>	<p>---- MANUAL ----</p> <p>Next station</p> <p>Previous station</p> <p>Turn to station no.</p> <p>Move up</p> <p>Move down</p>
---	---

	<p>The counter clockwise movement (see Right Turn) from position 12 to 1 is not possible and will be blocked by the system. To reach position 1, the turning table must be turned backwards (i.e., clockwise; left turn).</p> <p>The movement of the turning table is not possible if the lifting unit is lowered.</p>
---	--

8.2 QUICKSTART

In quick start mode all incubation times are equal for all positions.

Step 1

<p>Select Quickstart by pressing <input type="button" value="v"/> or <input type="button" value="^"/>.</p> <p>Press <input type="button" value="ENTER"/> to start the quick start menu.</p>	<p style="text-align: center;">---- MAIN MENU ----</p> <p>QUICKSTART</p> <p>PROGRAMS</p> <p>MANUAL</p> <p>SETUP</p> <p>22.01.21 15:30:10</p>
---	--

Step 2

<p>Select No. of baskets by pressing <input type="button" value="v"/> or <input type="button" value="^"/>.</p> <p>Press <input type="button" value="ENTER"/> to change the number of transport baskets used in the run.</p> <p>Changes are stored by pressing <input type="button" value="ENTER"/> again.</p>	<p style="text-align: center;">---- QUICKSTART ----</p> <p>No. of baskets 1</p> <p>Exposure 00:05:00</p> <p>Drip off time 00:30</p> <p>Temperature 65°C</p> <p>Start</p>
---	---





Step 3

<p>Select Exposure by pressing <input type="button" value="v"/> or <input type="button" value="^"/>.</p> <p>Press <input type="button" value="ENTER"/> to change the identical incubation time in all positions.</p> <p>Changes are stored by pressing <input type="button" value="ENTER"/> again.</p> <p>(e.g., 5 minutes in this example)</p>	<p style="text-align: center;">---- QUICKSTART ----</p> <p>No. of baskets 1</p> <p>Exposure 00:05:00</p> <p>Drip off time 00:30</p> <p>Temperature 65°C</p> <p>Start</p>
---	---



Step 4

<p>Select Drip off time by pressing <input type="button" value="v"/> or <input type="button" value="^"/>.</p> <p>Press <input type="button" value="ENTER"/> to change the dripping time above all positions.</p> <p>Changes are stored by pressing <input type="button" value="ENTER"/> again.</p> <p>(e.g., 30 seconds is the minimum time in this example)</p>	<p style="text-align: center;">---- QUICKSTART ----</p> <p>No. of baskets 1</p> <p>Exposure 00:05:00</p> <p>Drip off time 00:30</p> <p>Temperature 65°C</p> <p>Start</p>
--	---





Step 5

<p>Select Temperature by pressing  or .</p> <p>Press  to change the temperature for the paraffin beakers.</p> <p>Changes are stored by pressing  again.</p>	<p style="text-align: center;">---- QUICKSTART ----</p> <table style="width: 100%;"> <tr> <td>No. of baskets</td> <td style="text-align: right;">1</td> </tr> <tr> <td>Exposure</td> <td style="text-align: right;">00:05:00</td> </tr> <tr> <td>Drip off time</td> <td style="text-align: right;">00:30</td> </tr> <tr> <td>Temperature</td> <td style="text-align: right;">65°C</td> </tr> <tr> <td>Start</td> <td></td> </tr> </table>	No. of baskets	1	Exposure	00:05:00	Drip off time	00:30	Temperature	65°C	Start	
No. of baskets	1										
Exposure	00:05:00										
Drip off time	00:30										
Temperature	65°C										
Start											





Step 6

<p>Select Start by pressing  or .</p> <p>Press  to start the run immediately.</p>	<p style="text-align: center;">---- QUICKSTART ----</p> <table style="width: 100%;"> <tr> <td>No. of baskets</td> <td style="text-align: right;">1</td> </tr> <tr> <td>Exposure</td> <td style="text-align: right;">00:05:00</td> </tr> <tr> <td>Drip off time</td> <td style="text-align: right;">00:30</td> </tr> <tr> <td>Temperature</td> <td style="text-align: right;">65°C</td> </tr> <tr> <td>Start</td> <td></td> </tr> </table>	No. of baskets	1	Exposure	00:05:00	Drip off time	00:30	Temperature	65°C	Start	
No. of baskets	1										
Exposure	00:05:00										
Drip off time	00:30										
Temperature	65°C										
Start											





Step 7

<p>Select Delayed start by pressing  or .</p> <p>Press  to change the end time of the run.</p> <p>Changes are stored by pressing  again.</p>	<p style="text-align: center;">---- QUICKSTART ----</p> <table style="width: 100%;"> <tr> <td>Start</td> <td></td> </tr> <tr> <td>Delayed start</td> <td></td> </tr> <tr> <td>Used / Failsafe 01</td> <td style="text-align: right;">01</td> </tr> <tr> <td>Used / Failsafe 02</td> <td style="text-align: right;">02</td> </tr> <tr> <td>Used / Failsafe 03</td> <td style="text-align: right;">03</td> </tr> </table>	Start		Delayed start		Used / Failsafe 01	01	Used / Failsafe 02	02	Used / Failsafe 03	03
Start											
Delayed start											
Used / Failsafe 01	01										
Used / Failsafe 02	02										
Used / Failsafe 03	03										

Step 8

<p>Select Used / Failsafe for each incubation position by pressing  or .</p> <p>Press  to select those positions that shall be active and for each position the stop position if the system fails to finish the run.</p> <p>Changes are stored by pressing  again.</p>	<p>---- QUICKSTART ----</p> <p>Start</p> <p>Delayed start</p> <table><tr><td>Used / Failsafe 01</td><td>01</td></tr><tr><td>Used / Failsafe 02</td><td>02</td></tr><tr><td>Used / Failsafe 03</td><td>03</td></tr></table>	Used / Failsafe 01	01	Used / Failsafe 02	02	Used / Failsafe 03	03
Used / Failsafe 01	01						
Used / Failsafe 02	02						
Used / Failsafe 03	03						

Step 9



<p>Select Jump to start by pressing  or .</p> <p>Press  to change to the start command.</p> <p>Press  again to start the run with defined running time and corresponding start delay.</p>	<p>---- QUICKSTART ----</p> <table><tr><td>Used / Failsafe 21</td><td>21</td></tr><tr><td>Used / Failsafe 22</td><td>22</td></tr><tr><td>Used / Failsafe 23</td><td>23</td></tr><tr><td>Used / Failsafe 24</td><td>24</td></tr><tr><td>Jump to start</td><td></td></tr></table>	Used / Failsafe 21	21	Used / Failsafe 22	22	Used / Failsafe 23	23	Used / Failsafe 24	24	Jump to start	
Used / Failsafe 21	21										
Used / Failsafe 22	22										
Used / Failsafe 23	23										
Used / Failsafe 24	24										
Jump to start											

For discontinuation of the run, please refer to section 8.6.



	<p>During incubation times, the device will automatically mix by moving the basket holder up and down. The mixing process takes place every 30 seconds by default.</p> <p>At the end of the run, the basket will stay in incubation station 12 until the user removes it.</p>
---	---

8.3 SETTING AND STORAGE OF CUSTOMIZED PROGRAMS







Step 1

<p>Select Programs by pressing  or .</p> <p>Press  to change to the Programs menu.</p>	<p style="text-align: center;">---- MAIN MENU ----</p> <p>Quickstart</p> <p>Programs</p> <p>Manual</p> <p>Setup</p> <p>22.01.21 15:30:10</p>
---	--



Step 2

<p>Select Edit program by pressing  or .</p> <p>Press  to change to editing mode for all programs.</p>	<p style="text-align: center;">---- PROGRAMS ----</p> <p>Prog. 01 Routine</p> <p>Edit program</p> <p>Start (01:04:50)</p> <p>Delayed start</p>
---	--



Step 3

<p>Select Name by pressing  or .</p> <p>Press  to change to editing mode for program name. Each letter or number can be changed by pressing  or . Press  to move to next letter.</p>	<p style="text-align: center;">---- EDIT PROGRAM 01 ----</p> <p>Name Routine____</p> <p>No. of baskets 1</p> <p>Station 01 00:05:00</p> <p>Station 02 00:00:15</p> <p>Station 03 00:01:00</p>
--	---



Step 4

<p>Select No. of baskets by pressing  or .</p> <p>Press  to change the number of baskets used.</p> <p>(only for devices with optional second transport basket)</p>	<p style="text-align: center;">---- EDIT PROGRAM 01 ----</p> <p>Name Routine____</p> <p>No. of baskets 1</p> <p>Station 01 00:05:00</p> <p>Station 02 00:00:15</p> <p>Station 03 00:01:00</p>
---	---



Step 5

<p>Select Station 01 by pressing  or .</p> <p>Press  to enter the editing mode for position 01.</p>	---- EDIT PROGRAM 01 ----	
	Name	Routine____
	No. of baskets	1
	Station 01	00:05:00
	Station 02	00:00:15
Station 03	00:01:00	



Step 6

<p>Select Vacuum by pressing  or .</p> <p>Press  to activate or deactivate the vacuum function position 01.</p> <p>Please note that this function will solely be available if the device is equipped with vacuum function for electrically heated paraffin beakers or reagent beakers.</p>	---- P01 STATION 01 ----	
	Vacuum	Off
	Exposure	01:00:00
	Drip off time	00:05
	Temperature	___ °C
	Failsafe pos.	01

Step 7

<p>Select Exposure by pressing  or .</p> <p>Press  to change the incubation time for position 01.</p>	---- P01 STATION 01 ----	
	Exposure	01:00:00
	Drip off time	00:05
	Temperature	___ °C
	Failsafe pos.	01
	Save	

Step 8

<p>Select Drip off time by pressing  or .</p> <p>Press  to change the drip off time between movement from position 01 to the next position.</p>	---- P01 STATION 01 ----	
	Exposure	01:00:00
	Drip off time	00:05
	Temperature	___ °C
	Failsafe pos.	01
	Save	

Step 9

<p>Select Temperature by pressing <input type="button" value="v"/> or <input type="button" value="^"/>.</p> <p>Press <input type="button" value="ENTER"/> to change the temperature settings of the heated paraffin beakers.</p>	<p style="text-align: center;">---- P01 STATION 01 ----</p> <table style="width: 100%;"> <tr> <td>Exposure</td> <td style="text-align: right;">01:00:00</td> </tr> <tr> <td>Drip off time</td> <td style="text-align: right;">00:05</td> </tr> <tr> <td>Temperature</td> <td style="text-align: right;">63 °C</td> </tr> <tr> <td>Failsafe pos.</td> <td style="text-align: right;">01</td> </tr> <tr> <td>Save</td> <td></td> </tr> </table>	Exposure	01:00:00	Drip off time	00:05	Temperature	63 °C	Failsafe pos.	01	Save	
Exposure	01:00:00										
Drip off time	00:05										
Temperature	63 °C										
Failsafe pos.	01										
Save											

Step 10

<p>Select Failsafe pos. by pressing <input type="button" value="v"/> or <input type="button" value="^"/>.</p> <p>Press <input type="button" value="ENTER"/> to select those positions that shall be active and for each position the stop position if the system fails to finish the run.</p>	<p style="text-align: center;">---- P01 STATION 01 ----</p> <table style="width: 100%;"> <tr> <td>Exposure</td> <td style="text-align: right;">01:00:00</td> </tr> <tr> <td>Drip off time</td> <td style="text-align: right;">00:05</td> </tr> <tr> <td>Temperature</td> <td style="text-align: right;">63 °C</td> </tr> <tr> <td>Failsafe pos.</td> <td style="text-align: right;">01</td> </tr> <tr> <td>Save</td> <td></td> </tr> </table>	Exposure	01:00:00	Drip off time	00:05	Temperature	63 °C	Failsafe pos.	01	Save	
Exposure	01:00:00										
Drip off time	00:05										
Temperature	63 °C										
Failsafe pos.	01										
Save											

Step 11

<p>Select Save by pressing <input type="button" value="v"/> or <input type="button" value="^"/>.</p> <p>Press <input type="button" value="ENTER"/> to save the entries for the selected position.</p>	<p style="text-align: center;">---- P01 STATION 01 ----</p> <table style="width: 100%;"> <tr> <td>Exposure</td> <td style="text-align: right;">01:00:00</td> </tr> <tr> <td>Drip off time</td> <td style="text-align: right;">00:05</td> </tr> <tr> <td>Temperature</td> <td style="text-align: right;">63 °C</td> </tr> <tr> <td>Failsafe pos.</td> <td style="text-align: right;">01</td> </tr> <tr> <td>Save</td> <td></td> </tr> </table>	Exposure	01:00:00	Drip off time	00:05	Temperature	63 °C	Failsafe pos.	01	Save	
Exposure	01:00:00										
Drip off time	00:05										
Temperature	63 °C										
Failsafe pos.	01										
Save											

Step 12

<p>Select Station 02 by pressing <input type="button" value="v"/> or <input type="button" value="^"/>.</p> <p>Press <input type="button" value="ENTER"/> to enter the editing mode for position 01.</p> <p>(Repeat Step 5 to Step 11 for all 12 resp. 24 stations.)</p>	<p style="text-align: center;">---- EDIT PROGRAM 01 ----</p> <table style="width: 100%;"> <tr> <td>Name</td> <td style="text-align: right;">Routine____</td> </tr> <tr> <td>No. of baskets</td> <td style="text-align: right;">1</td> </tr> <tr> <td>Station 01</td> <td style="text-align: right;">00:05:00</td> </tr> <tr> <td>Station 02</td> <td style="text-align: right;">00:00:15</td> </tr> <tr> <td>Station 03</td> <td style="text-align: right;">00:01:00</td> </tr> </table>	Name	Routine____	No. of baskets	1	Station 01	00:05:00	Station 02	00:00:15	Station 03	00:01:00
Name	Routine____										
No. of baskets	1										
Station 01	00:05:00										
Station 02	00:00:15										
Station 03	00:01:00										

Step 13



<p>Select Save (01) by pressing <input type="button" value="v"/> or <input type="button" value="^"/>.</p> <p>Press <input type="button" value="ENTER"/> to save the entries in program 01.</p>	<p>---- PROGRAMS ----</p> <table><tr><td>Station 22</td><td>00:05:00</td></tr><tr><td>Station 23</td><td>00:00:15</td></tr><tr><td>Station 24</td><td>00:01:00</td></tr><tr><td>Save (01)</td><td></td></tr><tr><td>Save at ...</td><td></td></tr></table>	Station 22	00:05:00	Station 23	00:00:15	Station 24	00:01:00	Save (01)		Save at ...	
Station 22	00:05:00										
Station 23	00:00:15										
Station 24	00:01:00										
Save (01)											
Save at ...											

Step 14



<p>Select Save at ... by pressing <input type="button" value="v"/> or <input type="button" value="^"/>.</p> <p>Press <input type="button" value="ENTER"/> to select a program number under which you would like to store the afore changed entries.</p>	<p>---- PROGRAMS ----</p> <table><tr><td>Station 22</td><td>00:05:00</td></tr><tr><td>Station 23</td><td>00:00:15</td></tr><tr><td>Station 24</td><td>00:01:00</td></tr><tr><td>Save (01)</td><td></td></tr><tr><td>Save at ...</td><td></td></tr></table>	Station 22	00:05:00	Station 23	00:00:15	Station 24	00:01:00	Save (01)		Save at ...	
Station 22	00:05:00										
Station 23	00:00:15										
Station 24	00:01:00										
Save (01)											
Save at ...											

8.4 RUNNING A PROGRAM



Step 1

<p>Select Programs by pressing  or .</p> <p>Press  to change to the Programs menu.</p>	<p style="text-align: center;">---- MAIN MENU ----</p> <p>Quickstart</p> <p>Programs</p> <p>Manual</p> <p>Setup</p> <p>22.01.21 15:30:10</p>
---	--



Step 2

<p>Select Prog. by pressing  or .</p> <p>Press  to select the program.</p>	<p style="text-align: center;">---- PROGRAMS ----</p> <p>Prog. 01 Routine</p> <p>Edit program</p> <p>Start (01:04:50)</p> <p>Delayed start</p>
---	--

Step 3

<p>Select a program that you want to start by pressing  or .</p> <p>Press  to select the program you want to start.</p>	<p style="text-align: center;">---- PROGRAM SELECT ----</p> <table border="0"> <tr> <td>01</td> <td style="text-align: right;">10:00</td> </tr> <tr> <td>02</td> <td style="text-align: right;">05:00</td> </tr> <tr> <td>03</td> <td style="text-align: right;">00:00</td> </tr> <tr> <td>04</td> <td style="text-align: right;">00:00</td> </tr> <tr> <td>05</td> <td style="text-align: right;">00:00</td> </tr> </table>	01	10:00	02	05:00	03	00:00	04	00:00	05	00:00
01	10:00										
02	05:00										
03	00:00										
04	00:00										
05	00:00										

Step 4

<p>Select Start by pressing  or .</p> <p>Press  to start the selected program.</p>	<p style="text-align: center;">---- PROGRAMS ----</p> <p>Prog. 01 Routine</p> <p>Edit program</p> <p>Start (01:04:50)</p> <p>Delayed start</p>
---	--

Step 5

<p>Load the basket to the lifting unit.</p> <p>Press  to start the run.</p>	<p>Load basket</p> <p>Enter = OK</p>
--	--------------------------------------

	<p>12:04:34</p> <p>Prog. 01 Daily</p> <p>01 Exposure 00:59:43</p>
--	---



For discontinuation of the run, please refer to section 8.6.

	<p>During incubation times, the device will automatically mix by moving the basket holder up and down. The mixing process takes place every 30 seconds by default.</p> <p>At the end of the run, the basket will stay in incubation station 12 until the user removes it.</p>
---	---



8.5 TIME DELAY

The MTP is equipped with a delay function that allows delaying the start of the run by a defined end of process time (99 hours) or a defined start of process time (999 hours). To change from end of process time to start of process time, please refer to 7.3 STANDARD SETTINGS.



Step 1

<p>Select Programs by pressing  or .</p> <p>Press  to change to the Programs menu.</p>	<p style="text-align: center;">---- MAIN MENU ----</p> <p>Quickstart</p> <p>Programs</p> <p>Manual</p> <p>Setup</p> <p>22.01.21 15:30:10</p>
---	--

Step 2

<p>Select Delayed start by pressing  or .</p> <p>Press  to activate the delayed start function.</p>	<p style="text-align: center;">---- PROGRAMS ----</p> <p>Prog. 01 Routine</p> <p>Edit program</p> <p>Start (01:04:50)</p> <p>Delayed start</p>
--	--

Step 3

<p>Change required end time or delay start of the run by pressing  or .</p> <p>Press  to store the set time and progress with the start of the run.</p>	<p style="text-align: center;">Set end time</p> <p style="text-align: center;">Tue 10:00</p>
--	--

Step 4

<p>Load the basket to the lifting unit.</p> <p>Press  to start the run.</p>	<p>Load basket</p> <p>Enter = OK</p>
--	--------------------------------------

Step 5

<p>The display will show the starting time of the run. Until start of the run the device will remain in the first incubation position.</p> <p>(e.g., 2 hours and 58 minutes in this example)</p>	<p>Starting program in</p> <p>02:58:00</p>
--	--



For discontinuation of the run, please refer to section 8.6.

	<p>After start of a run, the settings for time delay will be reset to 00:00:00.</p> <p>During incubation times, the device will automatically mix by moving the basket holder up and down. The mixing process takes place every 30 seconds by default.</p> <p>At the end of the run, the basket will stay in incubation station 12 until the user removes it.</p>
---	---



8.6 DISCONTINUATION OF A RUN

<p>Press  to discontinue or interrupt a run.</p>	<p>12:04:34</p> <p>Prog. 01 Daily</p> <p>01 Exposure 00:59:43</p>
---	---

Step 1

<p>Select Continue by pressing  or .</p> <p>Press  to continue the run without discontinuation.</p>	<p>12:04:34</p> <p>Continue</p> <p>Add specimen</p> <p>Abort</p>
--	---

Step 2

<p>Select Add specimen by pressing  or .</p> <p>Press  to lift the lifting unit temporarily to add a specimen and thereafter continue the run.</p> <p>The display will guide you through the process.</p>	<p>12:04:34</p> <p>Continue</p> <p>Add specimen</p> <p>Abort</p>
--	---

Or

<p>Select Abort by pressing  or .</p> <p>Press  to discontinue the run.</p>	<p>12:04:34</p> <p>Continue</p> <p>Add specimen</p> <p>Abort</p>
--	---

8.7 SHUT DOWN

To switch off the device, use the main switch at the backside of the unit. The device can only be switched off if programs are stopped or cancelled. If the device is switched off during a running program, the program will continue in battery mode.

8.8 TWIN BASKET OPTION

[only applicable to devices equipped with this feature]

In this Twin Basket configuration, the MTP is equipped with 3 wax beakers and 9 plastic reagent beakers. A second basket is added to the upper lifting arm.

The software will display temperatures of all 3 beaker positions.

In the programming procedure, it is possible to work with 1 or with 2 baskets. When two transport baskets are used within one run, the device starts with the first transport basket, which is incubated in position 1. As soon as basket 1 has passed the incubation time, the second transport basket can be mounted.

The device will stop as soon as basket 1 reaches beaker 12 and basket 2 reaches beaker 11.

Since the second transport basket automatically follows the first transport basket, the incubation times must be identical in all positions to ensure identical incubation conditions for both transport baskets.

8.9 HOOD

[only applicable to devices equipped with this feature]

This option contains the plastic hood with opening and the required spacers. The additional equipment protects the user from solvent vapors, which are discharged from the device via a suction system.

The hood can be opened by the two sliding doors.

In case of subsequent conversion

The hood is mandatory for optional fume extraction system (see section 8.10).

Installation of the hood is described in section 6.3.

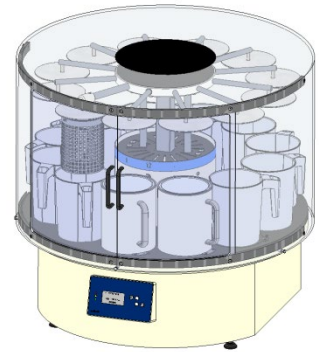

Carousel tissue processor MTP
with closed hood.

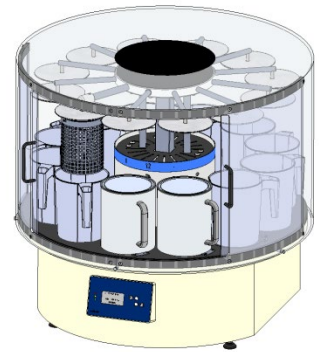

Carousel tissue processor MTP
with opened hood for loading
and unloading of device.

8.10 FAN / CARBON FILTER

[only applicable to devices equipped with this feature]

For greater user safety, solvent vapors can be removed directly from the device by using a fume extraction system. The extracted air can either be dissipated directly by an integrated fan or indirectly via an established fume extraction system. The fan can be activated in the menu adjustments and runs continuously in two separately programmable speeds for lifted or lowered lifting arm.

If the device is equipped with a carbon filter, the solvent vapors can be absorbed directly on the device via the filter. Without carbon filter, the suction must be connected to an already existing fume extraction system.

8.11 PARAFFIN VACCUUM FUNCTION

[only applicable to devices equipped with this feature]

The optional vacuum function can improve the infiltration of paraffin wax into the tissue sample. The vacuum is automatically activated during a program run when the basket moves into the paraffin wax beaker positions. Before lifting the basket out of the heated paraffin wax beakers, a magnetic valve normalises the pressure automatically.

The programming is described in section 8.3 SETTING AND STORAGE OF CUSTOMIZED PROGRAMS.

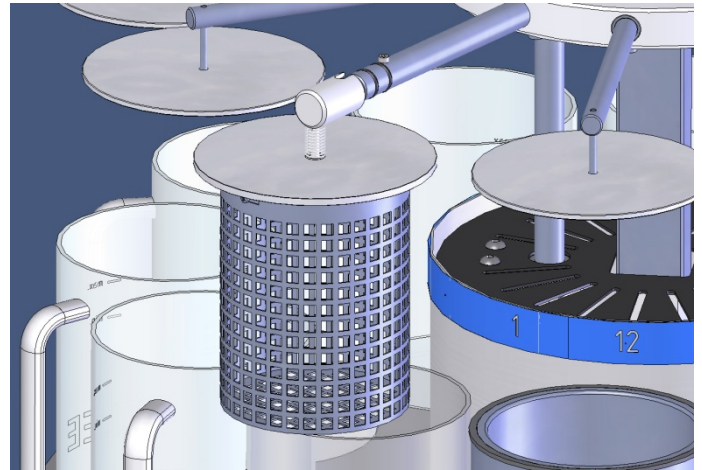

MTP with vacuum unit.

9 MAINTENANCE

Besides regular cleaning, the device is basically maintenance-free. A yearly inspection of the system is recommended (see 9.1 RECOMMENDED MAINTENANCE AND SERVICE SCHEDULE).

For cleaning the unit only use alcoholic media, not acetone or xylene. For the hood it is best to use a commercially available cleaner for plastics. The hood should not come in contact with alcoholic or other solvents!

Never spray or use cleaning medium directly onto the touch panels.

Please take note of the safety aspects of the device.

Wear protective clothing and disposable gloves according to Good Laboratory Practices.

9.1 RECOMMENDED MAINTENANCE AND SERVICE SCHEDULE

<p>Yearly</p>	<p>Complete service (performed by authorized Slee Service technician)</p> <ul style="list-style-type: none"> • Replacement of carbon filter • Check of battery alarm Functional check by forced disconnection • Testing and cleaning of all mechanical parts Functional check, cleaning with a soft cloth, optionally lubrication • Check of electrical parts Functional check of turning motor, lifting motor, vacuum system, exhaust fan Visual check of connections
<p>Every 4 Years</p>	<ul style="list-style-type: none"> • Replacement of backup batteries Nominal life time for integrated batteries is 4 years. The batteries must be disposed of according to existing local applicable regulations.

10 SERVICE

Internal components should only be serviced by technicians authorized by SLEE medical GmbH.

If technical service or spare parts are necessary, please contact your local SLEE medical GmbH distributor. Please have the following information available:

- Complete contact details
- Type of device and serial number
- Place of device and name of user
- Purpose of service call
- Delivery date of the unit

If it is necessary to return the device, it must be cleaned and disinfected before delivery. It must be returned in its original packing, to avoid transport damage.

If the device or parts thereof are sent back in a dirty or non-disinfected condition, SLEE medical GmbH reserves the right to return the parts to the debit of the customer without carrying out repairs or maintenance.

11 Optional accessories

Description	Item No.	MTP
Perspex hood	11000220	•
Twin basket option	11000221	•
Reagent beaker (POM, white, 2 liters)	11000251	•
Reagent beaker (aluminum, 2 liters)	11000229	•
Glass beaker	11000250	•
Heated paraffin beaker (aluminum)	11000252	•
Transport basket (stainless steel)	11000256	•
Carrier lid - prevents the cassettes from floating	11000257	•
Organizer tray, four-piece, for MTP (65 cassettes)	11000255	•
Vacuum system for MTP (standard) - integrated vacuum function for two paraffin-beakers	11000223	•
Vacuum system for MTP (Twin configuration) - integrated vacuum function for three paraffin-beakers	11000224	•
Vacuum system for MTP, complete - modification to 10 x reagent beakers (aluminum), 2,000 ml - integrated vacuum function for 2 paraffin beakers - integrated vacuum function for 10 reagent beakers (aluminum)	11000225	•
Vacuum system for MTP, complete (Twin configuration) - modification to 9 x reagent beakers (aluminum), 2,000 ml - integrated vacuum function for 3 paraffin beakers - integrated vacuum function for 9 reagent beakers (aluminum)	11000226	•
Exhaust fan	11000210	•
Exhaust fan including carbon filter	11000211	•
Exchange carbon filter	11000254	•
Remote alarm system	11000271	•

12 WARRANTY

SLEE medical GmbH guarantees that the product delivered has been subjected to a comprehensive quality control procedure, and that the product is faultless and complies with all technical specifications and/or agreed characteristics warranted.

SLEE medical GmbH guarantees that the device is manufactured under an ISO 9001:2015 and ISO 13485:2016 quality management system.

Unauthorized modification or repair by third party persons will void the warranty.

Only original SLEE spare parts must be used.

Guarantee claims can be put forward only if the device is used according to this manual and for the purpose described.

Mistakes and errors which occur because of improper use cannot be accepted.

13 DISPOSAL

The device or parts of the device must be disposed of according to existing local applicable regulations.

Notes

Notes

Notes



SLEE medical GmbH · Am Neuberg 14
55268 Nieder-Olm · Germany
www.slee.de

T: +49 (0) 6136 76997-0
E: mail@slee.de



www.slee.de



YouTube



LinkedIn



Instagram